

UEFA Club Licensing and Financial Fair Play CL/FFP IT Solution Toolkit

Edition 2018

CONTENTS

1. INTRODUCTION	2
2. SUMMARY OF THE CLUB MONITORING PROCESS	5
3. GUIDANCE FOR THE FINANCIAL STATEMENTS PACKAGE	7
4. GUIDANCE FOR THE CLUB INFORMATION PACKAGE	9
5. GUIDANCE FOR THE BREAK-EVEN PACKAGES	13
6. GUIDANCE FOR THE OVERDUE PAYABLES PACKAGES	27
APPENDIX I: KEY DATES AND DEADLINES FOR THE 2018/19 MONITORING PROCESS	38
APPENDIX II: THE LINKAGE BETWEEN THE FS PACKAGE AND THE BE PACKAGES	40
APPENDIX III: GUIDANCE FOR CI PACKAGE – GROUP STRUCTURE AND REPORTING PERIMETER	44
APPENDIX IV: GUIDANCE FOR FS & BE PACKAGES – INPUT SCHEDULES	52
APPENDIX V: GUIDANCE FOR BE PACKAGE – ADJUSTMENTS	80
APPENDIX VI: GUIDANCE FOR BE PACKAGE – THE BE.09 PACKAGE	104
APPENDIX VII: GUIDANCE FOR BE PACKAGE – REPORTING PERIODS OTHER THAN 12 MONTHS	113
APPENDIX VIII: GUIDANCE FOR BE PACKAGE – EXCHANGE RATES (OTHER THAN €)	115
APPENDIX IX: GUIDANCE FOR DUTY TO REPORT SUBSEQUENT EVENTS	116
APPENDIX X: GUIDANCE FOR APPLYING TO ENTER A VOLUNTARY AGREEMENT	117
INDEX	119

1. INTRODUCTION

1.1. The club monitoring requirements

The UEFA Club Licensing and Financial Fair Play Regulations (hereafter “the Regulations”) include Part III UEFA Club Monitoring also known as the “financial fair play” (FFP) requirements. All “Articles” or “Annexes” mentioned in this CL/FFP IT Solution Toolkit refer to the UEFA Club Licensing and Financial Fair Play Regulations.

The club monitoring requirements for licensees are:

- **break-even requirement** (Articles 58 to 64);
- **no overdue payables towards football clubs – enhanced** (Article 65);
- **no overdue payables in respect of its employees – enhanced** (Article 66);
- **no overdue payables towards social/tax authorities – enhanced** (Article 66bis); and
- **duty to report subsequent events** (Article 67).

The Regulations also address:

- the rights, duties and responsibilities of the parties involved (Articles 53 to 56);
- scope of application and exemption (Article 57); and
- other provisions common to all monitoring requirements (Articles 68 to 74).

All licensees that qualify for a UEFA club competition must comply with the club monitoring requirements for the entire monitoring process, regardless of whether their participation in a UEFA competition ceases before the end of the licence season. Certain licensees will be exempt from the break-even requirement in accordance with Article 57(2).

Under certain circumstances, a licensee can apply to enter into a voluntary agreement for the fulfilment of the break-even requirement (Article 57(5) and Annex XII).

Licensors also have important responsibilities to fulfil in respect of the monitoring process (Article 55). These responsibilities include communicating to licensees about information submission requirements and deadlines, and acting to support their licence applicants/licensees in fulfilling the monitoring requirements. Licensors are also required to undertake certain assessment procedures in respect of monitoring documentation submitted by licensees (Annex IX F and G).

1.2. Purpose of this toolkit

This CL/FFP IT Solution Toolkit (“the FFP Toolkit”) provides guidance to help stakeholders understand the requirements for the provision of financial information by licensees via the CL/FFP IT Solution developed by UEFA (see section 1.3).

The FFP Toolkit is divided into sections with guidance covering:

- club monitoring process (section 2 and Appendix I);
- financial statements package (**the FS package**) (section 3 and Appendix II, IV);
- club information package (**the CI package**) (section 4 and Appendix III);
- break-even package (**the BE package**) (section 5 and Appendices IV, V, VI, VII, VIII, X);
- overdue payables package (**the OP package**) (section 6); and
- business plan package (**the BP package**) for applying for a voluntary agreement for the break-even requirement (Appendix X).

All “Appendices” mentioned in this CL/FFP IT Solution Toolkit refer to this FFP Toolkit.

This FFP Toolkit supersedes all previous versions of toolkits and guidance documents in respect of the club monitoring requirements.

If there is any discrepancy between this FFP Toolkit and the Regulations, the Regulations always prevail. The information contained in this FFP Toolkit is without prejudice of any eventual determination made by the UEFA Club Financial Control Body (“CFCB”) with regard to the enforcement of the Regulations.

1.3. CL/FFP IT Solution

UEFA has implemented an IT system (hereinafter referred to as the “CL/FFP IT Solution”) for the purpose of:

- gathering information from the licence applicants/licensees within the scope of the implementation, assessment and enforcement of the Regulations; and
- sharing information and documents with the licensors concerning their affiliated clubs within the scope of the implementation, assessment and enforcement of the Regulations.

Access to the CL/FFP IT Solution is restricted to the following registered users:

- licence applicants/licensees;
- licensors; and
- UEFA, including all UEFA officers and employees responsible for club licensing and financial fair play matters and/or the CL/FFP IT Solution, members of the CFCB, and authorised third parties working on behalf of UEFA in respect of club licensing and financial fair play.

Each registered user of the CL/FFP IT Solution is required to adhere to certain requirements, as set out in the terms and conditions of use for the CL/FFP IT Solution. If a licence applicant/licensee does not accept these terms and conditions, then it will not be able to access the CL/FFP IT Solution for submission of the relevant club monitoring information.

Additional technical guidance about accessing and using the CL/FFP IT Solution is available from the UEFA administration.

The URL of the CL/FFP IT Solution is currently <https://CL/FFP.uefa.ch/fcprod/>

1.4. Key changes in edition 2018 of the Regulations with regard to club monitoring

Key changes in edition 2018 of the Regulations (compared with edition 2015) with regards to club monitoring are summarised below:

- In addition to the break-even requirement for the current monitoring period (covering T, T-1 and T-2), licensees in breach of certain new indicators will also be subject to the break-even requirement for the projected monitoring period (covering T+1, T and T-1, as per Article 59) – see Section 5.
- Addition of new indicators (Article 62), being the Sustainable debt indicator and the Player transfer balance indicator. If in breach of these indicators, then a licensee must also be subject to the break-even requirement for the projected monitoring period (covering T+1, T and T-1, as per Article 59) – see Section 5.
- New requirement for the legal group structure (Article 46), for disclosure of the names of other football clubs related to the licence applicant/licensee – see Appendix III.
- Harmonisation of the accounting requirements for licence applicant/licensee in respect of the permanent and/or temporary transfer of a player’s registration, and for specific expense and revenue items (Annex VII).
- For the calculation of the break-even result:
 - New specific requirements for calculating the related party transaction adjustment for the transfer of a player’s registration between clubs that are related parties (Annex X) – see Appendix V;
 - Clarification that costs of operating leases must continue to be included as part of relevant costs, even if categorised as a right-of-use asset in annual financial statements – see Appendix IV; and
 - Clarification that costs in respect of an intangible asset other than player registrations can only be excluded from relevant costs if there was/is no income in respect of the same intangible asset – see Appendix IV.

- Clarification that any joint and several liability decided by a competent authority for the termination of a contract by a player is part of payables towards football clubs (Article 65) – see Section 6.

1.5. Licensee’s duty to provide complete and accurate information

The licensee must cooperate with the licensor, the UEFA administration and the CFCB in respect of their requests and enquiries, including the provision of information and documents in respect of all entities of relevance to the licensee’s reporting perimeter. The licensee must provide the licensor and the CFCB with all necessary information and/or relevant documents to fully demonstrate that the monitoring requirements are fulfilled, as well as any other document requested and deemed to be relevant for club monitoring decision-making (Article 56 (a), (b) and (c)).

Prior to submission of information using the CL/FFP IT Solution, a licensee must complete the management representation that all possible care has been taken to ensure that the information entered in the packages in the CL/FFP IT Solution is clear, accurate, reliable and complete in accordance with the requirements included in the Regulations, directives, toolkits and other information communicated to licensees.

The CFCB at all times will bear in mind the overall objectives of the Regulations, in particular to defeat any attempt to circumvent these objectives (Article 72(1)).

1.6. Licensee’s duty to report subsequent events

According to Article 56(d) the licensee must promptly notify the licensor in writing about any subsequent events that constitute a significant change to the information previously submitted to the licensor, including a change of legal form or legal group structure. Furthermore according to Article 67 the licensee must promptly notify the licensor in writing about any significant changes including, but not limited to, subsequent events of major economic importance until at least the end of the licence season.

The licensee must comply with Articles 56 and 67 throughout the entire monitoring process, regardless if a licensee is eliminated from a UEFA competition.

A “significant change” is an event that is considered material to the documentation previously submitted to the licensor in respect of the club licensing and/or club monitoring requirements, and that would require a different presentation if it had occurred prior to submission of the documentation. A significant change includes, but is not limited to, a subsequent event or condition of major economic importance as defined in Article 3. Further guidance is provided in **Appendix IX**.

The licensee’s written notification to the licensor about the significant change must include a description of the event or condition and an estimate of its financial effect, or a statement (with supporting reasons) that such an estimate cannot be made.

Having received notification of a significant change from a licensee, the licensor must promptly inform UEFA about all relevant information submitted by the licensee.

2. SUMMARY OF THE CLUB MONITORING PROCESS

The club monitoring process (Article 54) is the process that refers to the submission and assessment of information (including the decisions thereon) in relation to the club monitoring requirements. The UEFA administration manage it.

Appendix I sets out the **key dates and deadlines for the monitoring process** and describes which documentation requirements are applicable.

2.1. Club monitoring process key steps

1. The UEFA administration communicates to licensors and licensees about the club monitoring process, documentation requirements and the deadlines for submission of documentation to UEFA.
2. The licensor determines national deadlines for review of documentation and communicates these to the licence applicants/licensees.
3. By the deadline communicated by UEFA, all licence applicants (or their licensors) must submit minimum financial statements information (using the **FS package**) for benchmarking purposes. *Note: The submission of this information will pre-populate the BE package as further explained in **section 3** and **Appendix II**.*
4. The licensor ensures that, as a minimum, all licensees qualified on sporting merit for UEFA club competitions have signed the CL/FFP IT Solution – Terms and Conditions and have returned them to UEFA in order for the relevant licence applicants/licensees to be granted access for the use of the CL/FFP IT Solution that must be used for the submission of information to UEFA.
5. The licensee's submission of information is performed by entering and uploading information into the CL/FFP IT Solution unless otherwise requested by UEFA. By the deadline set by the licensor as specified under step 2, the licensee must prepare and submit its completed monitoring documentation, including:
 - the club information (using the **CI package**);
 - no overdue payables information as at 30 June, including transfer payables, employee payables and social/tax payables (using the **OP.06 package**); and
 - break-even information for each of reporting periods T-1 and T-2 (using the **BE.06 package**).
6. The licensor undertakes assessment procedures in respect of the licensee's submitted documentation. As part of its assessment, the licensor may request additional/revised information from the licensee.
7. By the set deadline, the licensor submits the validated documentation to UEFA administration. In submitting this documentation, the licensor is confirming that its assessment procedures have been completed and it must highlight any matters that may be of relevance to the CFCB.
8. If requested, the licensee must submit player transfer balance information in respect of a player registration period ending during the licence season.
9. If the licensee exhibits any of the conditions described by indicators 1 to 6 of Article 62, or if otherwise requested by the CFCB, then by the set deadline the licensee must prepare and submit to the licensor their completed monitoring documentation, including:
 - break-even information for reporting period T and information about contributions (using the **BE.09 package**);
 - projected break-even information for reporting period T+1 (using the **BE.09 package**); and
 - break-even information for reporting periods T-3 and T-4 (if applicable).
10. If the licensee has overdue payables as at 30 June, or if otherwise requested by the CFCB, then by the set deadline the licensee must prepare and submit to the licensor its completed monitoring documentation, including:
 - no overdue payables documentation as at 30 September (using the **OP.09 package**).
11. The licensor undertakes assessment procedures in respect of the licensee's submitted documentation. As part of the assessment procedures, the licensor may request additional/revised information from the licensee. *Note: If the break-even information first submitted for reporting period T is based on unaudited financial statements, then the licensor will not need to perform assessment procedures until the monitoring documentation is re-submitted by the licensee and is based on audited financial statements.*

12. By the set deadline, the licensor submits the validated documentation to UEFA. In submitting this documentation, the licensor is confirming that its assessment procedures have been completed and it must highlight any matters that may be of relevance to the CFCB.
13. The CFCB, supported as appropriate by the UEFA administration and independent experts, undertakes the assessment of the monitoring documentation and takes the appropriate decisions, including the possibility of concluding a settlement agreement with the licensee, taking into consideration other factors as defined in Annex XI, and takes appropriate measure(s) without delay in accordance with the Procedural Rules Governing the UEFA Club Financial Control Body.
14. The CFCB and/or UEFA administration may request additional information from the licensee/licensor during the monitoring process. The licensor and the licensee must cooperate with the CFCB in respect of its requests and enquiries (Articles 55 and 56).

3. GUIDANCE FOR THE FINANCIAL STATEMENTS PACKAGE

The Financial Statements package (**FS package**) in the CL/FFP IT Solution is for the submission of financial information in respect of a licence applicant's reporting period ending in the previous calendar year, in order to:

- be used (if applicable) to pre-populate some elements of the BE package (profit and loss account, balance sheet and cash flow schedules) for those licensees subject to the club monitoring requirements in the following licence season as explained in **Appendix II**; and
- develop club benchmarking, in accordance with Article 2.

A licence applicant must carefully determine the appropriate reporting perimeter. Further guidance is given in **Appendix III**. For the preparation and submission of financial information for the FS package, a licence applicant must use the same reporting perimeter as used for club licensing.

3.1. Responsibilities of licence applicants

3.1.1. Summary of documentation to be submitted

FS package schedules	Requirements	Guidance reference
Club information	Check the information disclosed in the schedule: <ul style="list-style-type: none"> – the reporting currency – the reporting period closing month If incorrect, please contact the UEFA administration (ffpsupport@uefa.ch) before inputting any information into any schedules.	<ul style="list-style-type: none"> • Section 3.1.3
	Complete the club information schedule, including the following: <ul style="list-style-type: none"> – legal information – reporting information 	<ul style="list-style-type: none"> • Section 3.1.3 • Section 4.1.4
Balance sheet	Complete the balance sheet schedule.	<ul style="list-style-type: none"> • Section 3.1.4
Profit and loss account	Complete the profit and loss account schedule. If necessary for the appropriate understanding of the financial data, provide additional explanations about the following profit and loss account lines by using the relevant comment boxes: <ul style="list-style-type: none"> – exceptional income and expenses – other (non-operating) income and expenses – non-football operations income and expenses 	<ul style="list-style-type: none"> • Section 3.1.4 • Appendix IV (B)
Cash flow statement	Complete the cash flow statement schedule, including the cash and cash equivalents reconciliation.	<ul style="list-style-type: none"> • Section 3.1.4 • Appendix IV (C)
Reconciliation and additional information	Complete the reconciliations: <ul style="list-style-type: none"> – total equity reconciliation – player registrations reconciliation – tangible fixed asset reconciliation 	<ul style="list-style-type: none"> • Appendix IV (A)

3.1.2. Timing of submission

The licence applicant must prepare the information in the FS package and submit it to its licensor for onward submission to the UEFA administration by the set deadline notified by the UEFA administration. The key dates and deadlines are shown in **Appendix I**.

3.1.3. Club information

Before inputting any data into any FS schedule, the licensee must contact the UEFA administration if:

- the pre-populated **reporting currency** showing in the club information schedule is different from the presentation currency of the annual financial statements of the reporting entity/ies; and/or

- the pre-populated **reporting period closing month** is different from the actual reporting period closing month.

If a licensee has a reporting period that is greater or less than 12 months, please refer to the additional guidance in **Appendix VII**.

Within the FS package the licence applicant must submit certain **legal** and **reporting information** in respect of the relevant reporting period. The licence applicant must ensure that the required disclosures are completed in full. If an information request is not applicable, then enter “n/a” (not applicable).

See **section 4.1.4** for further guidance.

3.1.4. Profit and loss account, balance sheet and cash flow statement information

The financial information for the FS package must cover the same reporting perimeter for which financial information must be prepared and submitted for the purposes of club licensing and club monitoring.

The financial information to be input into the FS package must be based on and reconciled to the financial statements and underlying accounting records for the licence applicant’s reporting perimeter for the reporting period ending in the previous calendar year (in the FS package schedules, this is designated as T-1). Audited financial information must be used as the basis for preparation of the FS package.

For some licence applicants, the information in the FS package will be pre-populated from information that was previously input into the BE.09 package (see **Appendix II**). The information must be checked and amended, if necessary, before submission.

If input previously, the FS package schedules will also disclose the figures for the preceding reporting period (in the FS package schedules, this is designated as T-2).

The layout and information requests within the FS package schedules are based on the corresponding schedules in the BE package (refer to **section 5.1.3**). The licence applicant must input figures to the FS package schedules in accordance with the account line definitions in Annex VI and as further explained in **Appendix IV**.

Figures must be input into the schedules as follows:

- in the licence applicant’s reporting currency;
- entered in thousands and rounded to the nearest thousand (e.g. €1,234,567 should be entered as €1,235);
- for the balance sheet, all items must be input as positive figures;
- for the profit and loss account, all income items must be input as positive figures and all expenses items as negative figures; and
- for the cash flow statement, all items of cash inflow must be input as positive figures and all items of cash outflow as negative figures.

The licence applicant must complete the **reconciliation checks** in the reconciliations and cash flow statement schedules:

- reconciliation of total equity– see **Appendix IV (A.4)**;
- reconciliation of intangible assets (player registrations)– see **Appendix IV (A.4)**;
- reconciliation of tangible fixed assets – see **Appendix IV (A.4)**; and
- cash and cash equivalents reconciliation – see **Appendix IV (C.1)**.

3.2. Responsibilities of licensors

Whilst the FS package is submitted to the UEFA administration via the licensor, there are no formal assessment procedures that must be performed by the licensor.

The licensor may agree to help licence applicants to prepare the information for the FS package, in which case the licensor must ensure this information is submitted to the UEFA administration by the set deadline.

4. GUIDANCE FOR THE CLUB INFORMATION PACKAGE

The Club Information package (**CI package**) in the CL/FFP IT Solution is for:

- the submission of **legal group structure** and **reporting perimeter information**; and
- the submission of **contact details** relating to the licensee.

A licence applicant/licensee must carefully determine the appropriate reporting perimeter. Further guidance is given in **Appendix III**.

For the preparation and submission of financial information for club monitoring, a licensee must use the same reporting perimeter as used to fulfil the club licensing criteria, unless there has been a change of circumstances.

4.1. Responsibilities of licensees

4.1.1. Summary of documentation to be submitted

CI package schedules	Requirements	Guidance reference
Club information	Check the information disclosed in the schedule: <ul style="list-style-type: none"> – the reporting currency – the reporting period closing month If incorrect, then please contact the UEFA administration (ffpsupport@uefa.ch) before inputting any information into any packages.	<ul style="list-style-type: none"> • Section 4.1.3
	Disclose the required legal information , including: <ul style="list-style-type: none"> – legal form of the licensee – ultimate controlling party Disclose the required reporting information : <ul style="list-style-type: none"> – reporting perimeter – stadium recognition and ownership – audit opinion on financial statements – protection from creditors and/or insolvency proceedings – length of reporting period 	<ul style="list-style-type: none"> • Section 4.1.4 • Appendix III
	Attach to the CI package the legal group structure document (also identifying the reporting perimeter).	<ul style="list-style-type: none"> • Section 4.1.4
Contact details	Enter the contact details of the licensee to be used by the UEFA administration and CFCB.	<ul style="list-style-type: none"> • Section 4.1.5
Management representation	Complete the management representation to validate the information and confirm that the legal group structure document is attached to the CI package.	<ul style="list-style-type: none"> • Section 4.1.6

4.1.2. Timing of submission

All licensees must provide the prescribed information in the CI package for each of the reporting periods T-2, T-1 and T at the same time as the BE.06 and OP.06 packages are submitted.

For some licensees, the information in the CI package for T-2 and/or T-1 will be pre-populated from the information that was previously input into a prior year CI package.

In accordance with Article 67, licensees must promptly notify their licensor (and consequently the UEFA administration) if there are any changes to the club information in respect of reporting period T, and thereafter such licensees may be requested to submit an updated version of the CI package.

Those licensees that are required to also prepare and submit the BE.09 and/or OP.09 packages must make management representations (within the respective packages) that the information in the previously submitted CI package in respect of reporting period T and/or at the assessment date is also complete and accurate for reporting period T+1 (unless there has been a change).

4.1.3. Currency and reporting period information

Prior to inputting any data in any package, the licensee must contact the UEFA administration if either:

- (i) the pre-populated **reporting currency** showing in the club information schedule is different from the presentation currency of the annual financial statements of the reporting entity/ies; and/or
- (ii) the pre-populated **reporting period closing month** is different from the actual reporting period closing month.

If the presentation currency is something other than the euro, the club information schedule will display the relevant exchange rates for each reporting period. Please refer to the additional guidance in **Appendix VIII** with regard to financial information which is denominated in a currency other than euros.

If a licensee has a reporting period that is greater or less than twelve months, please refer to the additional guidance in **Appendix VII**.

4.1.4. Legal and reporting information

Within the CI package the licensee must submit certain **legal** and **reporting information** for each relevant reporting period (T-2, T-1 and T).

The licensee must ensure that the required disclosures are fully completed for each of the reporting periods. If an information request is not applicable, then enter “n/a” (not applicable). If a required disclosure is the same as the previous reporting period, then the user can copy and paste the information from one cell to another.

The licensee must provide the following **legal information**:

- full legal name and legal form of the licensee;
- If the licensee is not also the registered member of the national association and/or its affiliated league, the full legal name and legal form of the registered member;
- details about the ultimate controlling party of the licensee:
 - name of the ultimate controlling party; and
 - legal form of the ultimate controlling party, being one of (1) a person (2) an association (3) a foundation (4) a limited company (5) that there is no controlling party, or (6) a government;
 - If the ultimate controlling party is a limited company (option 4), names of all parties that have a 10% or greater direct and/or indirect ownership of the licence applicant/licensee, and/or 10% or greater voting rights and/or have significant influence over the ultimate controlling party; and
- name(s) of the party(ies) having significant influence (as per Article 3) over the licensee (if applicable); and
- name of any other football club, in respect of which any of the parties identified in Article 46(2) (a) to (f) or any of their key management personnel have any ownership interest, voting rights, and/or any involvement or influence whatsoever in relation to the governance of its financial and operating policies

The licensee must provide the following **reporting information**:

- Identify if the reporting perimeter covers only one entity (“single entity”) or, if the reporting perimeter covers more than one entity, disclose if the financial information is presented as a consolidated group (“consolidated financial statements”) or some other combination (“combined financial statements”). As set out in Article 46bis, the reporting perimeter is the entity or combination of entities in respect of which financial information must be prepared and submitted for the purposes of both club licensing and club monitoring.
- If consolidated financial statements, disclose the full legal name of the reporting entity for which there is consolidated financial information.
- If combined financial statements, disclose the full names of all entities included in the reporting perimeter.
- If applicable, list the name of any entity from the list in Article 46bis(2) that is excluded from the reporting perimeter, and an explanation about the justification for exclusion.
- Declaration that all revenues and costs related to each of the football activities listed in Article 46bis(3) have been included in the reporting perimeter, and provide an explanation if this is not the case.

- Indicate how the stadium assets are reflected in the reporting perimeter – either (1) the stadium is fully included within fixed assets, (2) the stadium is fully included as an investment, (3) the stadium is partially included within fixed assets, i.e. leasehold improvements are included, (4) the stadium assets are completely outside the reporting perimeter.
- Indicate the main owner of the stadium – either (1) the stadium is directly owned by the football club, (2) government owned, (3) owned by the parent company, owner of the football club or other related party, (4) owned by another party.
- Indicate if there is a note on players' economic rights in the financial statements or supplementary information.
- Identify the nature of the audit opinion in respect of the annual financial statements: (1) clean opinion, (2) adverse or disclaimer of opinion, (3) key audit matter regarding going concern, (4) qualified opinion regarding going concern, (5) qualified opinion or key audit matter regarding an item other than going concern, (6) unknown opinion.
- The length of the reporting period if not 12 months.

For club monitoring, the licensee must attach to the CI package the legal group structure document(s) (including the reporting perimeter as defined in Article 46bis, clearly identified on the document) in respect of reporting period T (and for T-1 and T-2, if different). In respect of T-1, this same documentation also had to be submitted to the licensor for the immediately preceding club licensing requirements.

4.1.5. Contact details

The licensee must also disclose other information in the schedule that is correct at the time of submission, and which will be used, if necessary, for correspondence from the UEFA administration and/or the CFCB to the licensee:

- full legal name and postal address of the licensee;
- email address of the licensee;
- telephone and fax numbers of the licensee; and
- confirmation that the contact details are the same as those contained in the latest extract from a public register and/or from the relevant UEFA member association's club register.

4.1.6. Management representation

The licensee must validate the CI package prior to submission by completing the management representation schedule, certifying that:

- *“On behalf of the executive body of the licensee, we hereby certify that all possible care has been taken to ensure that the information entered in the CL/FFP IT Solution is clear, accurate, reliable and complete in accordance with the requirements included in the UEFA Club Licensing and Financial Fair Play Regulations, directives, toolkits and other information communicated to licensees.”*
- *“The legal group structure document(s) (including the reporting perimeter as defined in Article 46bis clearly identified on the document) in respect of each relevant reporting period has (have) been attached to the CI package.”*

The licensee should also provide details of any unusual items or events of major economic importance experienced during the reporting period, as well as any subsequent events after the reporting period, by entering a brief description in the box provided and describing any supporting documentation attached to the package. The licensee's management representative must be on the list of authorised signatories for club licensing purposes.

4.2. Responsibilities of licensors

4.2.1. Introduction

In accordance with Articles 54 and 55, each licensor has important responsibilities to fulfil in respect of the club monitoring process, including assessment of certain aspects of each licensee's submitted information and confirmation of such to the UEFA administration and CFCB.

A licensor will have access to the schedules and information submitted by its licensees in the CL/FFP IT Solution, but will not be able to edit this information. The licensor will only be able to edit the Licensor assessment schedule.

If the licensor identifies a potential issue and/or error, then it is expected that the licensor will first contact the licensee and request the licensee to clarify the issue and/or correct the error in the CL/FFP IT Solution (for re-submission of the package(s) to the licensor).

The licensor must confirm that the assessment procedures have been completed and highlight any exceptions arising by completing the Licensor assessment schedule.

4.2.2. Assessment procedures

As a minimum, the licensor's assessment procedures in respect of the CI package are as follows:

Licensor assessment schedule – CI package	
Schedule	Licensor's assessment procedures
Management representation	<ul style="list-style-type: none"> Check that the licensee's signatory in the management representation schedule is on the list of authorised signatories as already held for club licensing.
Club information	<ul style="list-style-type: none"> For the reporting period T-2 and T-1: assess whether or not the 'legal information' and 'Reporting information' corresponds to the information as submitted for club licensing. For the reporting period T: read the licensee's 'Legal information' and 'Reporting information' in respect of reporting period T and make additional enquiries of the licensee if there is any information that may be incomplete and/or inaccurate based on the licensor's existing knowledge of the licensee from club licensing and/or other reasonable information sources; and highlight any changes and/or concerns to the UEFA administration by completing the 'If exceptions identified, please describe' cell. Check that the legal group structure document(s) (including the reporting perimeter, as defined in Article 46bis, clearly identified on the document) in respect of each relevant reporting period has (have) been attached to the CI package.

5. GUIDANCE FOR THE BREAK-EVEN PACKAGES

The break-even package (**BE package**) in the CL/FFP IT Solution is for the submission and assessment of financial information in respect of a licensee's reporting perimeter for the break-even requirement (Articles 58 to 64).

For each licence season there are two BE packages in the CL/FFP IT Solution:

- The **BE.06 package** which is mandatory for all licensees that qualify for a UEFA club competition, for reporting periods T-1 and T-2. This package (in particular the profit and loss account, balance sheet and cash flow) will be pre-populated with figures from the previous year's BE.09 package, or the current year's FS package if the BE.09 package was not completed in the previous year.
- The **BE.09 package** which is mandatory if a licensee is considered to be in breach of an indicator 1 to 6 of Article 62 (see **section 5.1.6**) or if otherwise requested by the CFCB, for reporting periods T, T+1 and, if applicable, T-3 and T-4.

5.1. Responsibilities of licensees

5.1.1. Summary of documentation to be submitted

BE package schedules	Requirements	BE.06 package	BE.09 package			Guidance reference
		T-1 & T-2	T	T+1	T-3 & T-4 *	
Balance sheet	Complete the balance sheet schedule, including the reconciliation checks .	✓	✓	✓	✓	<ul style="list-style-type: none"> • Section 5.1.3 • Appendix IV (A)
Profit and loss account	Complete the profit and loss account schedule.	✓	✓	✓	✓	<ul style="list-style-type: none"> • Section 5.1.3 • Appendix IV (B) • Appendix VI (A)
Profit and loss account – supplementary schedules	If applicable, complete the supplementary schedules to provide additional disclosure about particular profit and loss account lines: <ul style="list-style-type: none"> – gate receipts – sponsoring and advertising – broadcasting rights – commercial revenues – other operating income – cost of sales/materials – employee benefits expense – other operating expenses – player transfers – finance income/expenses – other income or expenses 	✓	✓	✗	✗	<ul style="list-style-type: none"> • Section 5.1.3 • Appendix IV (B)
Profit and Loss Account – assumptions	Describe assumptions for the projected break-even information schedules.	✗	✗	✓	✗	<ul style="list-style-type: none"> • Section 5.1.10
Indicator – supplementary schedule	If applicable, complete the supplementary schedule about debt directly attributable to the construction and/or substantial modification of : <ul style="list-style-type: none"> – the stadium, and/or the training facilities 	✓	✓	✗	✗	<ul style="list-style-type: none"> • Section 5.1.6

BE package schedules	Requirements	BE.06 package	BE.09 package			Guidance reference
		T-1 & T-2	T	T+1	T-3 & T-4 *	
Adjustments	If applicable, complete the adjustment schedules for: <ul style="list-style-type: none"> – transaction(s) with related parties – non-monetary items – non-football operations not related to the club – expenditure on youth development activities – expenditure on community development activities – expenditure on women's football activities – excess proceeds on disposal of tangible fixed assets – profit/loss on disposal and amortisation/Impairment of intangible assets – finance costs directly attributable to tangible fixed assets – costs of leasehold improvement – player accounting adjustments – credit arising from procedures providing protection from creditors – relating to settlement agreements 	✓	✓	✓	✓	<ul style="list-style-type: none"> • Section 5.1.4 • Appendix V
Cash flow statement	Complete the cash flow statement schedule.	✓	✓	✓	✓	<ul style="list-style-type: none"> • Section 5.1.3 • Appendix IV (C)
Going concern and negative equity	Complete the going concern and negative equity schedule.	✓	✗	✗	✗	<ul style="list-style-type: none"> • Section 5.1.6
Contributions	If applicable, complete the schedule for contributions for the monitoring period.	✗	✓	✓	✗	<ul style="list-style-type: none"> • Appendix VI (B)
Management representation	Complete the management representation schedule.	✓	✓			<ul style="list-style-type: none"> • Section 5.1.11

* Disclosure of information for reporting periods T-3 and T-4 is optional for the licensee.

5.1.2. Break-even information and timing of submission

A **monitoring period** covers three consecutive reporting periods on which a licensee is assessed for the purpose of the break-even requirement:

The **current monitoring** period comprising:

- T, being the reporting period ending in the same calendar year that the UEFA club competitions commence;
- T-1, being the reporting period ending in the calendar year before commencement of the UEFA club competitions; and
- T-2, being the reporting period preceding T-1.

In addition, for a licensee in breach of the indicators in Article 62(3) v) and/or vi), the **projected monitoring period** covering:

- T+1, being the 12 month period commencing immediately after the statutory closing date of the reporting period T;
- T, being the reporting period ending in the same calendar year that the UEFA club competitions commence; and
- T-1, being the reporting period ending in the calendar year before commencement of the UEFA club competitions.

For the purpose of the break-even requirement, a licensee must prepare and submit financial information for a reporting period ending in each relevant calendar year, regardless of their actual statutory closing date.

The figures to be input into the CL/FFP IT Solution must be based on and reconciled to the relevant annual financial statements and underlying accounting records of the entities in the licensee's reporting perimeter.

All licensees that qualify for a UEFA club competition must prepare (for exemptions see **Section 5.1.5**) and submit the break-even information in respect of each of the reporting periods T-1 and T-2 using the **BE.06 package**.

If a licensee exhibits any of the conditions described by indicators 1 to 6 in Article 62, or if otherwise requested by the CFCB, then it will be required to complete and submit the **BE.09 package** by the relevant deadline, containing the following information:

- Licensees with a **reporting period T ending on or before 31 July** must submit break-even information for T (based on and reconciled to their audited financial statements and underlying accounting records) and also their projected break-even information for reporting period T+1, by the October deadline.
- Licensees with a **reporting period T ending after 31 July** (and by no later than the following 31 December) may first submit break-even information for T (based on unaudited financial information) by the October deadline. Thereafter, by the March deadline during the licence season, such licensees must prepare and submit **updated break-even information** for reporting period T (based on and reconciled to their audited financial statements and underlying accounting records), and their projected break-even information for reporting period T+1.

Projected break-even information must cover the reporting period T+1, being the 12-month period commencing immediately after the closing date of reporting period T. In accordance with Article 63, projected break-even information must be prepared and submitted in the prescribed format as contained in the schedules in the BE.09 package.

A licensee may also take account of a break-even surplus of the **sum of the break-even results of the two reporting periods prior to the monitoring period**, by entering a '1' in the 'YES' column of the applicable question in the management representation schedule and then completing the applicable schedules in the BE.09 package. Once the licensee has activated and completed the information, the sum of the break-even results for the two reporting periods prior to the monitoring period will automatically appear on the licensee's break-even calculation output report schedule.

5.1.3. Profit and loss account, balance sheet and cash flow statement

The licensee must input information for each relevant reporting period into the profit and loss account, balance sheet and cash flow statement schedules in the BE packages as set out in the prescribed formats in the CL/FFP IT Solution.

The profit and loss account, balance sheet and cash flow schedules in a BE package will be pre-populated with figures from a previously submitted BE package or from the FS package. Further guidance is provided in **Section 3** and **Appendix II**.

It is the licensee's responsibility to ensure that the BE package is fully and accurately completed for club monitoring.

Certain figures to be input into the BE package will already be calculated and disclosed in the licensee's previously submitted club licensing documentation. Other figures may require calculation by the licensee's management from the underlying accounting records of the entity/ies in the reporting perimeter. Further guidance is provided in **Appendix IV**.

Some licensees must also complete some of the following supplementary schedules as part of a licensee's submission of the BE package by the set deadline, to provide a breakdown of:

- gate receipts;
- sponsoring and advertising;
- broadcasting rights;
- commercial revenues;
- other operating income;
- cost of sales/materials;
- employee benefits expense;
- other operating expenses;
- player transfers;
- finance income/expenses; and
- other income or expenses.

The requirement to complete one or more supplementary schedule is determined on the basis of the data entered in the profit and loss account and adjustment schedules, and is automatically notified to the licensee in the BE package. The supplementary schedules require a licensee to disclose more information about particular profit and loss account lines and/or adjustments.

In addition, for indicators 4 and 5 in Article 62, the licensee may complete the supplementary schedule to provide information about debt directly attributable to the stadium and/or training facilities.

Figures must be input into the BE package in the licensee's presentation currency (as used for its audited financial statements) and rounded to the nearest thousand. If applicable, the figures entered in the BE package will be automatically converted from the presentation currency into euros by application of the exchange rates in the CL/FFP IT Solution, being the average exchange rate for each relevant reporting period. Further guidance is provided in **Appendix VIII**.

5.1.4. Adjustments for the calculation of the break-even result for a reporting period

The break-even result for a reporting period is the difference between relevant income and relevant expenses, as defined in Article 58 and Annex X. If relevant income is greater than relevant expenses, the licensee has a break-even surplus for a reporting period. If relevant income is less than relevant expenses, the licensee has a break-even deficit for a reporting period.

Relevant income, relevant expenses and the break-even result for a reporting period must be calculated in accordance with the Articles 58 and 60 by the licensee inputting figures into the profit and loss account and adjustment schedules in the BE package in the CL/FFP IT Solution.

In order to calculate the relevant income and relevant expenses, **certain adjustments will be automatically identified in the BE package** to effectively exclude the amount (if any) for each of the following account lines:

- depreciation of tangible fixed assets;
- impairment of tangible fixed assets;
- profit/loss on disposal of tangible fixed assets; and
- tax income/expense.

The licensee must also input further information for the following **manual adjustments** to be included in the calculation of the break-even result:

- transaction(s) with related parties;
In the supplementary schedule for transactions with related parties, the licensee must disclose the prescribed information for all transactions with a related party, irrespective of whether or not there is an adjustment for the calculation of the break-even result.
- exclusion of non-monetary items;
- exclusion of the results of non-football operations not related to the club;
In the supplementary schedule for non-football operations, the licensee must disclose the prescribed information for all non-football operations, irrespective of whether or not there is an adjustment for the calculation of the break-even result.
- expenditure on youth development activities;
- expenditure on community development activities;
- expenditure on women’s football activities;
- excess proceeds on disposal of tangible fixed asset – (i) asset being replaced, and (ii) asset (excluding stadium or training facilities) not being replaced;
- finance costs directly attributable to the construction and/or substantial modification of tangible fixed assets;
- costs of leasehold improvements;
- amortisation/impairment of intangible assets (other than player registrations);
- profit/loss on disposal of intangible assets (other than player registrations);
- player transfers adjustments – (i) if a licensee using the income and expense method of accounting for player registrations in its annual financial statements chooses to apply the capitalisation and amortisation method for the purpose of the break-even calculation; (ii) if a licensee using the capitalisation and amortisation method of accounting for player registrations does not otherwise apply the UEFA requirements for player accounting, and/or (iii) if income recorded in respect of a player for whom the licensee retains the registration;
- credit in respect of a reduction of liabilities arising from procedures providing protection from creditors; and
- information relating to financial contributions under a settlement agreement.

The licensee must fully complete the prescribed information requirements for each adjustment schedule for each relevant reporting period. Further guidance is provided in **Appendix V**.

Further adjustments may also be made to a licensee’s relevant income and relevant expenses: (i) by the UEFA administration to reclassify amounts between account lines, with any such reclassifications having no impact on the break-even result (“**FS reclassification**”), and (ii) by the CFCB, based on the assessment of the monitoring documentation, to make adjustments to certain account lines that will impact on the calculation of the break-even result (“**BE correction**”).

5.1.5. Exemption from the break-even requirement

All licensees that qualify for a UEFA club competition must firstly prepare and submit the CI package and the BE.06 package in the CL/FFP IT Solution.

A licensee that demonstrates that they have relevant income and relevant expenses (as defined in Article 58) below €5m in respect of each of the two reporting periods ending in the two years before commencement of the UEFA club competition is exempt from the break-even requirement. Such an exemption decision is taken by the CFCB and is final.

The relevant income and expenses for a reporting period are calculated in the CL/FFP IT Solution based on the figures input by the licensee into the profit and loss account and adjustment schedules.

As per Article 57, if the reporting period is greater or less than 12 months, the €5m threshold (relevant income/expenses) for exemption is adjusted up or down according to the length of the reporting period. The flexed threshold level is then compared with the licensee’s relevant income and expenses as appropriate. See further guidance in **Appendix VII**.

5.1.6. Indicators

The use of indicators is part of the risk-based approach whereby those licensees that exhibit certain ‘warning signs’ will be subject to more extensive requirements.

If a licensee exhibits any of the conditions described by indicators 1 to 6 in Article 62, or if otherwise requested by the CFCB, it will be required to complete and submit the BE.09 package by the relevant deadline, as detailed in **Section 5.1.2**.

If a licensee breaches indicator 5 and/or 6, then it must also be assessed for the purpose of the break-even requirement for the projected monitoring period (covering reporting periods T-1, T and T+1).

A licensee will be assessed against the following six indicators from Article 62:

- **Indicator 1: Going concern issue and Indicator 2: Negative equity**

The licensee must complete the going concern and negative equity schedules in the BE.06 package, based on the annual financial statements for T-1 and interim financial statements (where applicable);

- **Indicator 3: Break-even result**

The licensee must submit break-even information for T-2 and T-1 in the BE.06 package.

- **Indicator 4: Sustainable debt indicator for T-1**

The licensee must complete the supplementary schedule for the debt directly attributable to the construction and/or substantial modification of the stadium and/or training facilities at the end of T-1.

Relevant debt is calculated as the net debt (from the licensee’s balance sheet submission as part of the break-even information), less the amount of debt that is directly attributable to the construction and/or substantial modification of the stadium and/or training facilities, from the inception of this debt until 25 years after the date when the asset is declared ready for use.

Relevant earnings is calculated from the licensee’s profit and loss submission as part of the break-even information.

The licensee is in breach of indicator 4 if the relevant debt at the end of reporting period T-1 is greater than EUR 30 million and greater than 7 times the average of the relevant earnings for T-1 and T-2.

- **Indicator 5: Sustainable debt indicator for T**

For those licensees required to submit break-even information for reporting period T, the licensee must complete the supplementary schedule for the debt directly attributable to the construction and/or substantial modification of the stadium and/or training facilities at the end of T.

The licensee is in breach of indicator 5 if the relevant debt at the end of reporting period T is greater than EUR 30 million and greater than 7 times the average of the relevant earnings for T, T-1 and T-2.

The financial information related to the debt directly attributable to the construction and/or substantial modification of the stadium and/or training facilities is entered in local currency by clicking on the indicators section of the homepage of the BE.06 package.

All balances except the one related to the debt attributable to the stadium and training facilities are populated directly from the financial information entered in the break-even package.

V. Sustainable Debt indicator		YES		
	T-1-LC	T-1-EUR	T-2-EUR	
Net Borrowings	-86'705		-104'046	
Net player transfers balance	34'748		41'698	
Accounts Payable to Social/Tax Authorities (nc)	0		0	
Net Debt	-51'957		-62'348	
Debt attributable to the stadium/training facilities (optional)	-15'000		-18'000	
Relevant debt	-36'957		-44'348	
Total Revenue ex Player Trading	677'690		813'228	756'236
Total Operating expenses (inc. EBE)	-317'783		-381'340	-420'153
Total Player Transfers	-43'660		-52'392	-256'897
Relevant earnings	316'247		379'496	79'186
Average relevant earnings (T-1, T-2)			229'341	
Sustainable Debt indicator			0.19	

[Click to enter details](#)

If a licensee enters a figure for debt directly attributable to the stadium/training facilities, then a supplementary schedule with the asset(s) information and its financing must be completed.

Reminder Debt attributable to the stadium/training facilities (optional)	15'000
Check	0

Asset type 1	Asset description	Asset value (T-1-LC)	Date ready for use
	Upper stands refurbishment	20'000	12/12/2012

Debt provider	Debt closing balance (T-1-LC)	Explanation (incl. Debt type, Contract Curr. & Amount - if diff. from LC)	Debt closing balance (T-1-EUR)	Inception date	Debt maturity (in years)
Debt provider 1	Bank ABC	10'000 bien	10'000	12/12/2012	20
Debt provider 2	United bank DEF	5'000 mieux	5'000	12/12/2020	15
Debt provider 3					
Debt provider 4					
Debt provider 5					
Debt provider - Other					
Total Debt Asset type 1		15'000	15'000		

The licensee must provide information about:

Stadium and/or training facilities asset:

- Asset(s) description; description of the asset type for which the debt is directly attributable.
- Asset(s) value; historical cost of the asset in local currency.
- Date ready for use; date in the format dd/mm/yyyy when the stadium and/or training facilities asset(s) was ready for use following construction or substantial modification. If the asset is still under construction, please enter “under construction”.

Directly attributable debt:

- Debt Provider; enter the name of the debt provider that advances cash to fund the asset construction and/or substantial modification. It must be entered by asset type and provider.
 - Debt closing balance (LC); amount of debt as at the end of the reporting period expressed in the local currency of the licensee.
 - Explanation (including debt type, contract currency and amount); describe the principle features of the debt (e.g. secured loan, bonds, fixed term, rate, lease), the debt currency, and the original amount of the debt.
 - Debt closing balance EUR; amount of debt as at end of the reporting period automatically converted by the CL/FFP IT solution.
 - Inception date; date in the format dd/mm/yyyy when funds are available to the reporting entity(ies).
 - Debt maturity (in years); Number of years remaining prior to the final payment.
- **Indicator 6: Player transfer balance**
If requested, the licensee must complete the supplementary package TR.01 for player transfers in respect of a player registration period.

The licensee is in breach of indicator 6 if its player transfer deficit is greater than EUR 100 million for any player registration period that ends during the licence season.

Incoming players are defined as follows:

- **Incoming players** are relevant professional players, who were transferred-in and/or registered (including loans) with the club at any time within the defined player registration period (i.e. transfer window). This also includes the registration of out-of-contract players, player coming back from loan as well as youth players signing their first professional contract.

INCOMING PLAYER								In Transfer
	Player name	Former club	Date of Transfer			Costs incurred transfer fee *		Transfer Currency (TC)
			DD	MM	YYYY	EUR	Transfer Currency	
Summer								
PLAYER-01	player A	Team A	1	7	2018	41'396'200	41'396'200	EUR
PLAYER-02	player B	Team B	31	7	2018	21'300'000	21'300'000	EUR
PLAYER-03	player C	Team C	1	7	2018	4'500'000	4'500'000	EUR
Total						67'196'200		

For all players' registrations transferred-in during the relevant registration period, information covering:

- **Player's name**; the player's name as shown on the document of the player's registration.
- **Former club**; name of the previous club from which the player's registration has been transferred either permanently or on loan.
- **Date of transfer**; the date the player's registration transferred-in to the acquiring club. For international transfers, this date should be the same as that required to be entered in FIFA's Transfer Matching System ("TMS") in the format dd/mm/yyyy.
- **Cost incurred**; transfer fee costs of acquiring a player's registration incurred during the player registration period, being amounts paid and/or payable for agreed transfer compensation, realised conditional transfer compensation, and solidarity/training compensation. This balance is calculated automatically.
- **Transfer Currency ("TC")**; currency of the payables as specified in the transfer or loan agreement with the former club.

Currency (TC)		In Reporting Currency (LC)						
Unconditional Amount (TC)	Conditional		Amount (TC) Description (list all conditions)	Training Compensation and Solidarity Contribution (TC)	Reporting currency	Other Direct Cost (LC)	Agent / Intermediary (LC)	Club owns 100% of the future transfer proceeds (no TPO or sell-on clause)
	realised	Unrealised						
29'520'300	9'322'200			1'553'700	EUR	0	1'000'000	0
2'375'000	17'500'000			125'000	EUR	0	1'300'000	0
3'800'000		11'000'000		200'000	EUR	0	500'000	0
35'695'300	26'822'200	11'000'000		1'878'700		-	2'800'000	-

- **Unconditional Amount** (to be entered in TC); the original amount paid and/or payable not subject to conditions to the former club from which the player's registration has been transferred permanently or on loan.

- **Conditional Amount** (to be entered in TC); any conditional amounts agreed with the former club of the player that are realised in the player registration period. Also disclose any conditional amounts not yet realised (which are noted, but are not included in the cost incurred transfer fee).
- **Description** (list all conditions); brief summary of conditions attached in contract.
- **Training Compensation and Solidarity Contribution** (to be entered in TC); the total amount paid and/or payable in respect of “Training / Solidarity compensation” in regard to the transfer.
- **Reporting/Local Currency (“LC”)**; currency which is used for the club’s financial statements.
- **Other Direct Costs** (to be entered in LC); being the total amount of other direct costs paid and/or payable by the club to third parties in relation to the transfer-in of a player’s registration, but excluding amounts paid/payable to other football clubs and excluding amounts paid/payable to agents (which are requested separately).
- **Agent fees** (to be entered in LC); being the total amount of fees paid and/or payable by the club to agents/intermediaries in relation to the transfer-in of a player’s registration. This amount excludes any contingent payables. This amount includes any fees paid/payable by the club to an agent/intermediary on behalf of player concerned.

Outgoing players are defined as follows:

- **Outgoing players** are professional players who were transferred-out or left the club for any other reasons at any time within the relevant player registration period.

OUTGOING PLAYER							In Transfer	
#	Player name	New club	Date of Transfer			Transfer proceeds		Transfer Currency (TC)
			DD	MM	YYYY	EUR	Transfer Currency	
Summer 18								
PLAYER-01	player D	Team D	18	8	2018	28'297'766	28'297'766	EUR
PLAYER-02	player E	Team E	11	8	2018	12'098'825	14'155'625	CHF
PLAYER-03	player F	Team F	3	7	2018	2'200'000	2'200'000	EUR
		Total				42'596'590	44'653'391	

- **Player’s name**; the player’s name as shown on the document of the player’s registration.
- **New club**; name of the new club to which the player’s registration has been transferred permanently or on loan.
- **Date of transfer**; the date the player’s registration transferred-out to the new club. For international transfers, this date should be the same as that required to be entered in FIFA’s Transfer matching System (“TMS”) in the format dd/mm/yyyy.
- **Transfer proceeds**; transfer fee proceeds of transferring-out a player’s registration during the player registration period, being amounts received and/or receivable for agreed transfer compensation, realised conditional transfer compensation, and solidarity/training compensation due to the club. This balance will be calculated automatically.
- **Transfer Currency (“TC”)**; currency of the receivable as specified in the transfer or loan agreement with the new club.

Currency (TC)			In Reporting Currency (LC)					
Unconditional Amount (TC)	Conditional Amount (TC)		Description (list all conditions)	Training Compensation and Solidarity Contribution (TC)	Reporting Currency (LC)	Other Direct Costs (LC)	Agent / Intermediary (LC)	sell-on liabilities to previous club
	Realised Amount	Unrealised Amount						
28'601'250	2'712'188	3'287'812		1'565'672	EUR	0	1'450'000	3'131'344
14'155'625	0	1'500'000		0	CHF	0	0	0
2'200'000	0	300'000		0	EUR	0	0	0
44'956'875	2'712'188	5'087'812		1'565'672	0	0	1'450'000	3'131'344

- **Unconditional Amount** (to be entered in TC); the original amount received and/or receivable not subject to condition(s) from the new club to which the player's registration has been transferred permanently or on loan.

If the buyer/new club can retain from the total transfer proceeds a portion or all of the training and compensation fee due to other clubs, only the net transfer amount must be reported. A brief description must be provided.

- **Conditional Amount** (to be entered in TC); any amounts agreed with the new club of the player that are subject to condition(s) at the date of the contract signing as follows:

If the buyer/new club can retain from conditional amounts a portion or all of the training and compensation fee due to other clubs, only the net transfer amount must be reported. A brief description must be provided.

- **Realised amount:** any amounts received or receivable related to a condition that has been fulfilled since the end of the previous registration period or during the player registration period.
- **Unrealised amount:** any amounts to be potentially received related to a condition not yet completed during the player registration period. **This balance is not included in the calculation of the transfer proceeds.**
- **Description** (list all conditions): brief summary of conditions attached in contract and/or indicate the percentage of profit-sharing fee if there is a sell-on clause and/or percentage of deduction agreed as shared-fee for training and compensation.
- **Training Compensation and Solidarity Contribution** (to be entered in TC): the net amount received and/or receivable in respect of "Training / Solidarity compensation" as at the date of the contract signing. You must report only the amount owned by the club. If these amounts must be paid to other clubs and only transit via your accounts, they must not be reported.
- **Reporting Currency or Local Currency ("LC"):** currency which is used for the club's financial statements.
- **Other Direct Costs** (to be entered in LC) : being the total amount of fees paid and/or payable by the club to third parties in relation to the transfer-out of a player's registration, but excluding amounts paid/payable to agents (which are requested separately).
- **Agent fees** (to be entered in LC): being the total amount of fees paid and/or payable by the club to an agent/intermediary in relation to the transfer-out of a player's registration. This amount excludes any contingent payables. This amount includes any fees paid/payable by the club to an agent/intermediary on behalf of player concerned.
- **Sell-on liabilities:** (to be entered in LC): being the total amount of fees paid and/or payable by the club to the previous club of the player in relation to the transfer-out of a player's registration. This is deducted from the transfer proceeds.

5.1.7. Projected break-even information

Those licensees required to submit projected break-even information for T+1 in the BE.09 package must prepare that information on the following basis:

- using the same entity or combination of entities (i.e. the same reporting perimeter) as that used by the licensee for reporting period T for the break-even information, unless there has been a change;
- using the same accounting policies as those applied for the preparation of the annual financial statements, except for accounting policy changes made after the date of the most recent annual financial statements that are to be reflected in the next annual financial statements;
- using the same reporting currency as used for the licensee's preceding annual financial statements and entered to the nearest thousand; and
- using information and assumptions that are as up-to-date as practically possible; this means that the projected break-even information should be prepared during the month preceding submission.

5.1.8. Aggregate break-even result for a monitoring period

The aggregate break-even result is the sum of the break-even results of each of the three reporting periods covered by the relevant monitoring period. If the aggregate break-even result is positive (equal to zero or above), the licensee has an aggregate break-even surplus for the monitoring period. If the aggregate break-even result is negative (below zero), the licensee has an aggregate break-even deficit for the monitoring period.

For licence season 2018/19,

- the current monitoring period covers the reporting periods ending in 2018 (T), 2017 (T-1) and 2016 (T-2);
- the projected monitoring period covers the reporting periods ending in 2019 (T+1), 2018 (T) and 2017 (T-1)

In the case of an aggregate break-even deficit for the monitoring period assessed for licence season 2018/19, the licensee may demonstrate that the aggregate deficit is reduced by a surplus (if any) resulting from the sum of the break-even results of the reporting periods ending in :

- 2015 (T-3) and 2014 (T-4) for the current monitoring period; and
- 2016 (T-2) and 2015 (T-3) for the projected monitoring period.

5.1.9. The notion of acceptable deviation and contributions

Acceptable deviation is the maximum aggregate break-even deficit possible for a monitoring period in order for a licensee to be deemed to be in compliance with the break-even requirement (Article 61(1)).

The acceptable deviation is €5m. However, it can exceed this level up to €30m if such excess is entirely covered by contributions from equity participants and/or related parties.

In order to be considered for the break-even requirement, the licensee must input into the contributions schedule details of the amount, nature and timing of contributions from equity participants and/or related parties that have occurred and been recognised:

- For licensees assessed on the current monitoring period, (i) in audited financial statements for one of the reporting periods T-2, T-1, T and/or (ii) in the accounting records up until the deadline for submission of the break-even information for reporting period T.
- For licensees assessed on the projected monitoring period, (i) in audited financial statements for one of the reporting periods T-1, T and/or (ii) in the accounting records for the reporting period T+1 up until the end of the licence season.

If contributions occurring until the deadline for submission of the break-even information for the reporting period T are recognised in the reporting period T+1 and have been taken into consideration to determine the acceptable deviation in respect of the current monitoring period, then for later monitoring periods the contributions will be considered as having been recognised in reporting period T.

If a licensee has a reporting period greater or less than 12 months, then the acceptable deviation is adjusted up or down according to the length of the relevant monitoring period. See **Appendix VII** for further guidance.

The break-even calculation schedule in the BE.09 package summarises the break-even result for each reporting period, the aggregate break-even result for the monitoring period, contributions and a comparison with the acceptable deviation.

For the avoidance of doubt, contributions in the two reporting periods prior to the monitoring period are not applicable for the assessment of fulfilment or non-fulfilment of the break-even requirement.

5.1.10. Fulfilment of the break-even requirement

For the 2018/19 licence season, the break-even requirement for the current monitoring period is fulfilled if the licensee has:

:

- an aggregate break-even surplus for reporting periods T-2, T-1 and T (being FY16, FY17 and FY18 respectively); or
- the licensee has an aggregate break-even deficit for reporting periods T-2, T-1 and T (being FY16, FY17 and FY18 respectively) which is within the acceptable deviation, having also taken into account the surplus (if any) resulting from the sum of the break-even results in reporting periods T-3 (FY15) and T-4 (FY14).

For the 2018/19 licence season, the break-even requirement for the projected monitoring period is fulfilled if the licensee has:

- an aggregate break-even surplus for reporting periods T-1, T and T+1 (being FY17, FY18 and FY19 respectively); or
- an aggregate break-even deficit for reporting periods T-1, T and T+1 (being FY17, FY18 and FY19 respectively); which is within the acceptable deviation, having also taken into account the surplus (if any) resulting from the sum of the break-even results in reporting periods T-2 (FY16) and T-3 (FY15).

The break-even requirement is not fulfilled if the licensee has an aggregate break-even deficit exceeding the acceptable deviation for the current monitoring period and/or, if applicable, for the projected monitoring period. These scenarios are further illustrated in **Appendix VI (C)**.

5.1.11. Management representations

The licensee must validate the BE package prior to submission by completing the management representation schedule, certifying that:

- *“On behalf of the executive body of the licensee, we hereby certify that all possible care has been taken to ensure that the information entered in the CL/FFP IT Solution is clear, accurate, reliable and complete in accordance with the requirements included in the UEFA Club Licensing and Financial Fair Play Regulations, directives, toolkits and other information communicated to licensees.”*

The licensee’s management representative must be on the list of authorised signatories registered for club licensing purposes.

The management representation schedule also provides the licensee with the possibility to disclose:

- details of any unusual items or events of major economic importance experienced during the reporting period, as well as any subsequent events after the reporting period, by entering a brief description in the box provided and describing any supporting documentation attached to the package; and

- details of any prior period adjustments, either due to the correction of errors stated in the annual financial statements, a previous input error in the CL/FFP IT Solution and/or a change of reporting perimeter, by entering a brief description in the box provided and describing any supporting documentation attached to the package.

In the BE.09 package, licensees have two additional tasks to complete in the management representation schedule:

- confirming whether or not they want to take into account a break-even surplus resulting from the sum of the break-even results for reporting periods T-3 and T-4 and/or, if applicable, for reporting periods T-2 and T-3 for their break-even calculation; and
- certifying that the information previously entered in the CI package for reporting period T is still correct as at the date of submission of the BE.09 package.

5.2. Responsibilities of licensors

5.2.1. Assessment procedures for reporting periods T-1 and T-2 in the BE.06 package

See **Section 4.2.1** for the duties of the licensor.

As a minimum, the licensor's assessment procedures in respect of the BE.06 package are as follows:

Licensor assessment schedule – BE.06 package	
Schedule	Licensor's assessment procedures
Management representation	<ul style="list-style-type: none"> • Check that the licensee's signatory in the management representation schedule is on the list of authorised signatories as already held for club licensing.
Profit and loss account, balance sheet and cash flow statement	<ul style="list-style-type: none"> • Check that amounts contained in the break-even information submitted by the licensee are consistent with the amounts contained in the audited financial statements and/or supplementary information previously submitted for club licensing, the licensor's minimum assessment procedures in respect of the licensee's profit and loss account, balance sheet and cash flow statement schedules must include for each relevant reporting period: <ul style="list-style-type: none"> • a comparison of the "profit/loss after taxation" as reported in the profit and loss account schedule against "profit/loss after taxation" in the relevant audited financial statements as already held for club licensing; • a comparison of the "net assets/liabilities" as reported in the balance sheet schedule against 'Net assets/liabilities' in the relevant audited financial statements as already held for club licensing; and • a comparison of the "net cash inflow/(outflow)" as reported in the cash flow statement schedule against the "net cash inflow/(outflow)" in the relevant audited financial statements as already held for club licensing.
Transactions with related parties	<ul style="list-style-type: none"> • The licensor must assess whether transactions with related parties disclosed in the audited financial statements and/or supplementary information (as already held for club licensing) have also been entered in the relevant schedule in the CL/FFP IT Solution. • For each relevant reporting period, the disclosure of the names and amounts of transactions with related parties in the "transactions with related parties' schedule" must be compared against the relevant audited financial statements and/or supplementary information as already held for club licensing.
Going concern and negative equity	<ul style="list-style-type: none"> • Check that the information in the going concern and negative equity schedule is consistent with the financial statements (for reporting period T-1 and, if applicable, the interim financial statements) as already held for club licensing.

5.2.2. Assessment procedures for reporting period T in the BE.09 package

The licensor's assessment procedures in respect of the BE.09 package must be completed for the licensee's submission which is based on and reconciled to audited financial statements as follows:

- Licensees with a reporting period T ending on or before 31 July must submit by the set deadline their break-even information for T based on and reconciled to their audited financial statements. The licensor must have completed their assessment procedures in respect of this monitoring documentation by the October deadline.
- Licensees with a reporting period T ending after 31 July (and by no later than the following 31 December) may first submit break-even information for T based on unaudited financial information by the October deadline. At the October deadline the licensor will not need to perform assessment procedures in respect of break-even information for T that is based on unaudited financial information. The licensor must complete their assessment procedures for reporting period T based on the licensee’s updated break-even information (based on and reconciled to their audited financial statements and underlying accounting records) in time for submission to UEFA administration by the March deadline.

As a minimum, the licensor’s assessment procedures in respect of the BE.09 package are as follows:

Licensor assessment schedule – BE.09 package	
Schedule	Licensor’s assessment procedures
Management representation schedule	<ul style="list-style-type: none"> • Check that the licensee’s signatory in the management representation schedule is on the list of authorised signatories as already held for club licensing.
Profit and loss account, balance sheet schedules and cash flow statement schedules	<ul style="list-style-type: none"> • To check that amounts contained in the break-even information submitted by the licensee are consistent with the amounts contained in the audited financial statements and/or supplementary information for reporting period T, the licensor’s minimum assessment procedures in respect of the licensee’s profit and loss account and balance sheet schedules must include: <ul style="list-style-type: none"> • a comparison of the “profit/loss after taxation” as reported in the profit and loss account schedule against “profit/loss after taxation” in the audited financial statements; and • a comparison of the “net assets/liabilities” as reported in the balance sheet schedule against net assets/liabilities” in the audited financial statements; • a comparison of the “net cash inflow/(outflow)” as reported in the cash flow statement schedule against “net cash inflow/(outflow)” in the relevant audited financial statements.
Transactions with related parties	<ul style="list-style-type: none"> • The licensor must assess whether transactions with related parties disclosed in the audited financial statements and/or supplementary information for reporting period T have also been entered in the relevant schedule in the CL/FFP IT Solution as follows: <ul style="list-style-type: none"> • a comparison of the disclosure of the names and amounts of transactions with related parties in the “transactions with related parties’ schedule” with the audited financial statements and/or supplementary information.
Contributions from equity participants	<ul style="list-style-type: none"> • The licensor must assess whether contributions from equity participants in each of the reporting periods T-2, T-1 and/or T correspond to the audited financial statements as follows: <ul style="list-style-type: none"> • For each relevant reporting period, check that the amounts disclosed as contributions from equity participants in the contributions schedule are recorded as such in the relevant audited financial statements.

6. GUIDANCE FOR THE OVERDUE PAYABLES PACKAGES

The overdue payables package (**OP package**) in the CL/FFP IT Solution is for the submission and assessment of financial information in respect of a licensee’s reporting perimeter for the monitoring requirements for “no overdue payables towards football clubs” (Article 65), “no overdue payables in respect of employees” (Article 66) and “no overdue payables towards social/tax authorities” (Article 66bis).

For each licence season there are two OP packages in the CL/FFP IT Solution:

- the **OP.06 package** as at 30 June, which is mandatory for all licensees that qualify for a UEFA club competition; and
- the **OP.09 package** as at 30 September, which is required if a licensee has overdue payables as at 30 June, or if otherwise requested by the CFCB.

If applicable the amounts will be translated from the original currency of the payables into euros by application of the pre-populated exchange rates in the CL/FFP IT Solution (sourced from the European Central Bank or other appropriate sources) to reflect the exchange rates as at the assessment date.

6.1. Responsibilities of licensees

6.1.1. Summary of documentation to be submitted

OP Package schedule	Requirements	OP.06 package 30 June	OP.09 package 30 Sept	Guidance reference
Transfer table	Complete the transfer table schedule.	✓	✓	• Section 6.1.2
Employee table	Complete the employee table schedule.	✓	✓	• Section 6.1.3
Social/tax table	Complete the social/tax table schedule.	✓	✓	• Section 6.1.4
Management representation	Complete the management representation schedule to validate the information before submission.	✓	✓	• Section 6.1.6

As well as the mandatory information requested above, licensees also have the option of completing the **overdue transfer receivables** schedule in both the OP.06 and OP.09 packages. Further guidance is provided in Section 6.1.2.8.

The input information is then summarised in the output schedules titled “Summary”, “Transfer table output”, “Overdue transfer receivables summary” and “Overdue transfer receivables table output”.

6.1.2. Transfer table

The licensee must prepare and submit the information as prescribed in the transfer table schedule in the CL/FFP IT Solution.

6.1.2.1. Player transfers that must be disclosed

Within the transfer table summary schedule, the licensee must disclose:

- All new player registrations (including loan acquisitions) in the 12-month period up to 30 June/30 September, irrespective of whether there is an amount outstanding to be paid as at 30 June/30 September. This includes the transferring-in of out-of-contract players, but excludes youth players signing their first professional contract, unless this triggers a solidarity/training compensation payable. For out-of-contract players that are re-registering with a licensee, having played for the licensee in the previous season, the date of transfer may be amended rather than an additional line being added, as long as there is no payable due on this re-registration. Where there is a previous payable relating to this player, an additional line must be added for the re-registration.

- b) All player transfers for which an amount is outstanding to be paid as at 30 June/30 September, irrespective of whether they were undertaken in the 12-month period up to 30 June/30 September or before.
- c) All player transfers subject to a claim pending before the competent authority under national law or proceedings pending before a national or international football authority or relevant arbitration tribunal, as at 30 June/30 September.

The same player may be the subject of more than one entry to the Transfer table summary schedule if there are payables in respect of that player arising from two or more transfers (e.g. a loan extension, or a permanent transfer following an initial loan).

A licensee is not required to disclose as a new player registration for a player who returns to the licensee following a loan/temporary transfer to another club (unless there is a financial liability arising in respect of any such transfer).

Payables are those amounts due to football clubs as a result of transfer activities (including any amount due upon fulfilment of certain conditions), training compensation and solidarity contributions as defined in the FIFA Regulations on the Status and Transfer of Players, and any joint and several liability decided by a competent authority for the termination of a contract by a player..

Payables due to parties other than football clubs as a result of transfer activities are not payables for assessment under Article 65.

The following information must be disclosed in the **transfer table summary** for each player transfer:

- **player’s name**, as shown on the player’s registration document;
- **name of the former club** from which the player’s registration has been transferred permanently or on loan; if this club name is not an option in the pre-populated list, “Other” should be selected from the list and the name of the club entered manually in the “If other, please specify” cell;
- whether the player has been transferred **permanently** to the licensee club (select “Transfer”) or **temporarily** loaned to the licensee club (select “Loan”);
- **date** on which the player’s registration has been transferred-in permanently or on loan; for international transfers, this date should be the same as that required to be entered into FIFA’s Transfer Matching System (TMS);
- a declaration confirming the existence or absence of a transfer payable and/or disputed amount at the assessment date, by entering a ‘1’ in the applicable “open transfer” or “closed transfer” cell; and
- **currency** of the payables as specified in the transfer or loan agreement with the former club.

The initial data entry table in the transfer table summary schedule:

To insert a new player, click here		To delete a player, click here		Please enter data for open transfer												
Player name	Former club	If other, please specify	Loan or Transfer	Date of transfer			Please enter 1 in the correct box		Transfer currency	Agreed transfer compensation - total	Please enter in club reporting currency			Third Party Ownership Rights (% relinquished)	Co-ownership Rights (% relinquished)	Length of contract (original duration in years)
				Day	Month	Year	Open transfer	Closed transfer			Club reporting currency	Total Agent fees (LC)	Other direct costs on transfer (LC)			

For each player transfer which is “**closed**” (i.e. there is no amount outstanding to another club(s), nor is there a disputed amount as at the assessment date), the licensee only needs to disclose information in respect of “agreed transfer compensation”.

For each player transfer which is “**open**” (i.e. there is an amount outstanding to another club(s) and/or a disputed amount as at the assessment date), the licensee must disclose certain additional information in respect of “**agreed transfer compensation**”, “**conditional transfer compensation**” and “**solidarity/training compensation**”, as set out separately in the transfer details schedule as described further below.

In addition, in respect of each player transfer, the licensee must provide certain other information:

- “**Agent fees (total on transfer)**” – being the total amount of fees paid and/or payable by the licensee to agent(s) in relation to the transfer-in of a player’s registration. This amount excludes any contingent payables. This amount includes any fees paid/payable by the licensee to agent(s) on behalf of the player

concerned. The amount must be entered to the nearest thousand and in the reporting currency of the licensee concerned.

- **“Other direct costs of acquiring the registration”** – being the total amount of fees paid and/or payable by the licensee to third parties in relation to the transfer-in of a player’s registration, but excluding amounts paid/payable to football clubs and excluding amounts paid/payable to agents (which are requested separately). The amount must be entered to the nearest thousand and in the reporting currency of the licensee concerned.
- **“Third-Party Ownership Rights” (% relinquished)** – as at the assessment date, being the percentage of economic rights or similar in respect of the player that were owned by a party other than the club/licensee (where the other party is not another football club).
- **“Co-ownership Rights (% relinquished)”** – as at the assessment date, being the percentage of economic rights or similar in respect of the player that were held by another football club (excluding agreed transfer compensation, conditional transfer compensation, and solidarity/training compensation).
- **“Length of contract (original duration in years)”** – being the number of years (to the nearest round number) of the employment contract with the player, as originally contracted at the time of the player’s transfer-in to the licensee.

6.1.2.2. Agreed transfer compensation

‘Agreed transfer compensation’ is the **original unconditional amount** paid and/or payable to the former club from which the player’s registration has been transferred permanently or on loan. This amount does not change over time (in the currency of the payables).

For the avoidance of doubt, ‘Agreed transfer compensation’ does not include:

- any amounts that are conditional at the date of the transfer, as any such amounts will be classified as “conditional transfer compensation” when/if a condition is satisfied and a payable arises;
- solidarity contributions and/or training compensation, as any such amounts will be classified as “solidarity/training compensation”; or
- any amounts paid/payable to parties other than a football club (e.g. agents).

The licensee must enter the total amount paid and payable for ‘Agreed transfer compensation – total’, and the amount of ‘Agreed transfer compensation – paid by the original assessment date’. The balance of these two amounts is the ‘Agreed transfer compensation – payable as at the original assessment date’. Amounts must be input as positive figures, in the currency of the transfer contract, and rounded to the nearest thousand (e.g. €1,234,567 should be entered as €1,235).

The licensee must enter certain details for each instalment that makes-up the “agreed transfer compensation – payable as at the assessment date”:

- the instalment amount payable at the assessment date (to be rounded to the nearest thousand);
- the due date for the instalment to be paid, as per the original transfer agreement between the clubs;
- where applicable, the “post deferrals due date” for the instalment to be paid, as per an agreement in writing between the clubs; and
- where applicable, the amount and date of any payment in respect of any overdue instalments that has been made since the assessment date and by the date of the licensee’s submission of the information to the licensor.

In the transfer details schedule the ageing of any overdue amount will be automatically calculated, as the number of days between the due date of the instalment and the assessment date.

If a licensee has concluded an agreement in writing whereby the dates and/or the amounts of instalments have been revised from the original transfer agreement, then the licensee must enter the details of the instalments due at the assessment date and must enter the revised due dates in the cells for ‘Post deferrals due date’.

6.1.2.3. Disputed amounts

For the avoidance of doubt, amounts as at the assessment date which were originally due to be paid before the assessment date can only be disclosed as disputed (rather than overdue payables) if the licensee has a **legitimate dispute open** with an appropriate competent authority at the assessment date (in accordance with Annex VIII).

If the licensee has one or more instalments in respect of which there is a legitimate dispute, it must complete the disputes schedule, as shown below:

Player Name Former Club If other please specify Transfer / Loan Transfer Currency													
Party opening dispute	Date when claim/proceedings has been brought/have been opened			Disputed amount	Type of dispute	Competent authority hearing claim	Case number	Has/have claim/proceedings been contested? (Yes/No)	Date(s) when claim/proceedings has/have been contested			Status	Summary
	DD	MM	YY						DD	MM	YY		
Assessment date = end of 06.[year]													
Mandatory fields = color coded in light blue													

Within the **disputes schedule for player transfers** the licensee must disclose:

- the **name** of the party that opened the dispute and the date at which the proceedings were opened;
- the **amount** payable at the assessment date that is subject to a dispute (to be rounded to the nearest thousand);
- the **competent authority** with whom the dispute has been opened, the dispute case number (e.g. FIFA case number) and disclose if the proceedings have been contested;
- the **status** of the dispute (e.g. pending, awaiting grounds of decision, closed);
- a **brief summary** of the case, to further explain the nature of the case and current status; and
- relevant case **documentation** by attaching the document(s) to the OP package on submission.

The disputes schedule must be completed with the following information for disputed amounts in respect of **employees and social/tax authorities**:

- employee's **name**/name of relevant social/tax authority;
- employee's **employment position**;
- the name of the **party that opened the dispute** and the **date** at which the proceedings were opened;
- the **amount** that is subject to dispute, and the month in which it was originally due to be paid to the employee (specifying amounts in each of the six months prior to the assessment date, and inputting any amounts older than six months in the "Older" cell); amounts must be input as positive figures, in the licensee's reporting currency, and rounded to the nearest thousand;
- the **type of payable** which is being disputed (e.g. salary, bonus, signing-on fees, etc. for employees or sales tax, income tax etc. for social/tax authorities);
- the **competent authority** with whom the dispute has been opened, the dispute case number, as provided by the competent authority with whom the dispute has been opened, and disclose if the proceedings have been contested;
- a description of the **status** of the dispute;
- a **brief summary** of the case, to further explain the nature of the case and current status; and
- relevant case **documentation** by attaching the document(s) to the OP package on submission.

6.1.2.4. Conditional transfer compensation / Joint and several liability

"Conditional transfer compensation" is the amount payable to another football club because **certain conditions have been satisfied** at some point between the date of the transfer-in and the assessment date. That is, at the assessment date the 'conditional transfer compensation' payable is unconditional.

The licensee must enter certain details for each instalment of “conditional transfer compensation” as at the assessment date:

- the instalment amount payable at the assessment date (rounded to the nearest thousand);
- the due date for the instalment to be paid, as per the original transfer agreement between the clubs;
- where applicable, the “post deferrals due date” for the instalment to be paid, as per an agreement in writing between the clubs; and
- where applicable, the amount and date of any payment in respect of the instalment, made since the assessment date and by the date of the licensee’s submission of the information to the licensor.

If the licensee has one or more instalments in respect of which there is a legitimate dispute, it must complete the disputes schedule as detailed in Section 6.1.2.3 above.

“Joint and several liability” is the amount payable at the assessment date to another football club following the decision of a competent authority for the termination of a contract by a player.

The licensee must enter certain details for each instalment that makes-up the “joint and several liability for the termination of a contract by a player – payable as at the assessment date”:

- the instalment amount payable at the assessment date (rounded to the nearest thousand);
- the due date for the instalment to be paid, as per the decision of the competent authority; and
- where applicable, the amount and date of any payment in respect of the instalment, made since the assessment date and by the date of the licensee’s submission of the information to the licensor.

6.1.2.5. Solidarity/training compensation

The licensee must disclose:

- the total amount payable in respect of “solidarity/training compensation” as at the assessment date (to be rounded to the nearest thousand); and
- the total amount of payables in respect of “solidarity/training compensation” that was overdue as at the assessment date (to be rounded to the nearest thousand).

If the licensee has one or more instalments in respect of which there is a legitimate dispute, it must complete the disputes schedule as detailed in Section 6.1.2.3 above. As per **Annex VIII (2e)**, in respect of solidarity and training compensation (as defined in the FIFA Regulations on the Status and Transfer of Players), a licensee may disclose an amount as disputed if it is able to demonstrate to the reasonable satisfaction of the relevant decision-making bodies (licensor and/or UEFA CFCB) that it has taken all reasonable measures to identify and pay the creditor club(s). For these amounts the licensee must disclose within the disputes schedule the date of the last correspondence with the creditor club(s) and explanatory details, including the name of the creditor club(s) or national association(s) and a brief description of why the amount is pending.

6.1.2.6. Transfer summary for each player transfer

The transfer summary (converted to euros) sets out, for each player transfer, transfer amounts as at the assessment date analysed by “agreed transfer compensation”, “conditional transfer compensation”, “solidarity/training compensation”, and “joint and several liability”, and identifying separately:

- the amount of overdue payables – analysed by:
 - (i) amounts paid since the assessment date, and
 - (ii) overdue payables not paid since the assessment date; and
- the amount of transfer payables that is not overdue – analysed by
 - (i) amounts that have been deferred by written agreement,
 - (ii) amounts in dispute, and
 - (iii) payables that are not due at the assessment date.

The amounts in the transfer summary (in euros) are presented in euros to enable comparisons between licensees.

6.1.3. Employee table

6.1.3.1 Information to be input by all licensees

Each licensee must disclose certain information in the employee table schedule of the CL/FFP IT Solution for the 30 June assessment date, and some licensees must also complete the equivalent schedule for the 30 September assessment date.

Amounts must be input as positive figures, in the reporting currency of the licensee's annual financial statements (as disclosed in the CI package), and rounded to the nearest thousand (e.g. €1,234,567 should be entered as €1,235).

Each licensee must input:

- The **total amount of payables to employees as at the assessment date**. The definition of payables to employees is the same as for club licensing purposes (see Article 50(2) and (3)). For the avoidance of doubt, this amount must be equal to or greater than the sum of overdue payables, disputed amounts and deferred payables.
- A declaration confirming the existence or absence of overdue payables towards employees, by entering a '1' in the applicable "yes" or "no" cells for each of:
 - overdue payables to employees as at assessment date; and
 - overdue payables to employees that have been settled in whole or in part since the assessment date (and by the time of submission). If "yes", the amount settled since the assessment date must also be included in the "total employee payables at the assessment date" balance.
- A declaration confirming the existence or absence of payables towards employees that are not overdue but are disputed and/or deferred, by entering a '1' in the applicable "yes" or "no" cells for each of:
 - amounts to employees as at the assessment date that were in dispute; and
 - amounts to employees as at the assessment date which have been deferred, as per an agreement in writing with the employee.

In turn, the financial information in the employee table schedule is automatically aggregated, translated to euros, and included in the summary output schedule (see **section 6.1.5**).

For the avoidance of doubt, payables are all forms of consideration due in respect of employees as a result of contractual or legal obligations, including wages, salaries, image-rights payments, bonuses and other benefits. Amounts payable to people who, for various reasons, are no longer employed by the licensee fall within the scope of this requirement and must be settled within the period stipulated in the contract and/or defined by law.

For the purpose of Article 50 (for club licensing) and Article 66 (for club monitoring), the term "employees" refers to the following persons:

- all professional players according to the applicable FIFA Regulations on the Status and Transfer of Players; and
- the administrative, technical, medical and security staff specified in Articles 28 to 33 and 35 to 39, being the general manager, finance officer, media officer, medical doctor(s), physiotherapist(s), youth teams medic(s), security officer, supporter liaison officer, disability access officer, head coach of first squad, assistant coach of first squad, head of youth development programme, and youth coaches.

All forms of consideration for the benefit of employees must be accounted for in the books of one of the entities included in the reporting perimeter.

The initial data entry requirements in the employee table schedule:

Total employee payables at end of [year].June	<input type="text"/>			
Do you have any of the following?	Please enter '1' for Yes	Please enter '1' for No	Amounts in xxx	Amounts in EUR
Overdue at end of [year].June	<input type="text"/>	<input type="text"/>	<input type="text"/>	<input type="text"/>
Overdue paid post end of [year].June	<input type="text"/>	<input type="text"/>	<input type="text"/>	<input type="text"/>
Disputed at end of [year].June	<input type="text"/>	<input type="text"/>	<input type="text"/>	<input type="text"/>
Deferred at end of [year].June	<input type="text"/>	<input type="text"/>	<input type="text"/>	<input type="text"/>
Reporting currency	<input type="text"/>			

If the licensee declares that it does not have any overdue payables towards employees as at the assessment date, nor any deferrals or any disputes, then it does not need to disclose further information unless otherwise requested by the licensor and/or the CFCB.

If the licensee declares that it does have overdue, deferred and/or disputed payables towards employees as at the assessment date, then it must disclose further information as set out in the employee table schedule and as further described below.

6.1.3.2 Additional information to be disclosed by licensees where applicable

If the licensee declares that it does have **overdue payables** towards employees as at the assessment date, then it must disclose the following information in the employee table schedule:

- Employee's name.
- Employee's employment position, by selecting one of the three categories being "Player" (meaning a professional player), or "Coach" (meaning any of head coach of first squad, assistant coach of first squad, head of youth development programme, and/or youth coach), or "Staff" (meaning any of general manager, finance officer, media officer, medical doctor, youth teams medic(s), physiotherapist, security officer, supporter liaison officer and/or disability access officer.).
- The amount that is overdue, and the month in which it was originally due to be paid to the employee (specifying amounts in each of the six months prior to the assessment date, and inputting any amounts older than six months in the "Older" cell). Amounts must be input as positive figures, in the licensee's reporting currency, and rounded to the nearest thousand. The total amount that is overdue will be calculated automatically from the monthly figures.

If the licensee has **made payments against overdue payables since the assessment date** and by the date of the licensee's submission of information to the licensor, then the licensee must also disclose:

- Employee's name.
- Employee's employment position.
- The amount of any payment (to the employee in respect of overdue payables at the assessment date) made since the assessment date and by the date of the licensee's submission of the information to the licensor. Any such payments should be disclosed in the relevant month cell, in order to match against the overdue payable amount and month.

If the licensee has one or more instalments in respect of which there is a **legitimate dispute** at the assessment date, it must complete the disputes schedule as detailed in Section 6.1.2.3 above.

If a licensee has **payables to employees at the assessment date which have been deferred**, as per an agreement in writing with the employee, then the licensee must disclose the following information in respect of each such employee:

- employee's name;
- employee's employment position, selecting from the options of "Player", "Coach" or "Staff" (see above);
- the amount that is subject to deferral, and the month in which it was originally due to be paid to the employee (specifying amounts in each of the six months prior to the assessment date, and inputting any amounts older than six months in the "Older" cell); and
- The post deferrals due date(s) for the amount(s) to be paid to the employee, as per an agreement in writing with the employee.

For the avoidance of doubt, payables to employees at the assessment date which were originally due to be paid to the employee before the assessment date can only be disclosed as deferred (rather than overdue payables) if the licensee has concluded an agreement which has been accepted in writing by the employee(s) concerned that extends the due date beyond the applicable assessment date. The agreement in writing with an employee must not be obtained under duress or coercion.

6.1.4. Social/tax table

6.1.4.1 Information to be input by all licensees

Each licensee must disclose certain information in the social/tax authority table schedule of the CL/FFP IT Solution for the 30 June assessment date, and some licensees must also complete the equivalent schedule for the 30 September assessment date.

Amounts must be input as positive figures, in the reporting currency of licensee’s annual financial statements (as disclosed in the CI package), and rounded to the nearest thousand (e.g. €1,234,567 should be entered as €1,235).

Each licensee must disclose:

- The **total amount of payables to social/tax authorities at the assessment date**. For the avoidance of doubt, this amount must be equal to or greater than the sum of overdue payables, disputed payables and deferred payables.
- A declaration confirming the existence or absence of overdue payables towards social/tax authorities, by entering a ‘1’ in the applicable “yes” or “no” cells for each of:
 - overdue payables to social/tax authorities as at assessment date; and
 - overdue payables to social/tax authorities that have been settled in whole or in part since the assessment date (and by the time of submission). If “yes”, the amount settled since the assessment date must also be included in the “total social/tax payables at the assessment date” balance.
- A declaration confirming the existence or absence of payables towards social/tax authorities that are not overdue but are disputed and/or deferred, by entering a ‘1’ in the applicable “yes” or “no” cells for each of:
 - payables to social/tax authorities at the assessment date that were in dispute; and
 - payables to social/tax authorities at the assessment date which have been deferred, as per an agreement in writing with the social/tax authority.

In turn, the financial information in the social/tax authority table schedule is automatically aggregated, translated to euros and included in the summary output schedule (see **section 6.1.5**).

The initial data entry requirements in the social/tax table schedule:

Total social/tax payables at end of [year].June	<input type="text"/>			
Do you have any of the following?	Please enter '1' for Yes	Please enter '1' for No	Amounts in xxx	Amounts in EUR
Overdue at end of [year].June	<input type="text"/>	<input type="text"/>	<input type="text"/>	<input type="text"/>
Overdue paid post end of [year].June	<input type="text"/>	<input type="text"/>	<input type="text"/>	<input type="text"/>
Disputed at end of [year].June	<input type="text"/>	<input type="text"/>	<input type="text"/>	<input type="text"/>
Deferred at end of [year].June	<input type="text"/>	<input type="text"/>	<input type="text"/>	<input type="text"/>
Reporting currency	<input type="text"/>			

If the licensee declares that it does not have any overdue payables towards social/tax authorities at the assessment date, nor any deferrals or any disputes, it does not need to disclose further information unless otherwise requested by the licensor and/or the CFCB.

If the licensee declares that it does have overdue, deferred and/or disputed payables towards social/tax authorities at the assessment date, then it must disclose further information as set out in the Social/tax authority table schedule and as further described below.

6.1.4.2 Additional information to be disclosed by licensees where applicable

If the licensee declares that it does have **overdue payables** towards social/tax authorities as at the assessment date, then it must disclose the following information in the Social/tax authority table schedule:

- The name of relevant social/tax authority.
- The amount that is overdue, and the month in which it was originally due to be paid to the social/tax authority (specifying amounts in each of the six months prior to the assessment date, and inputting any amounts older than six months in the “Older” cell). Amounts must be input as positive figures, in the

licensee's reporting currency, and rounded to the nearest thousand. The total amount that is overdue will be calculated automatically from the monthly figures.

If the licensee has **made payments against overdue payables since the assessment date** and by the date of the licensee's submission of information to the licensor, then the licensee must also disclose:

- The name of relevant social/tax authority.
- The amount of any payment (to the social/tax authority in respect of overdue payables at the assessment date) made since the assessment date and by the date of the licensee's submission of the information to the licensor. Any such payments should be disclosed in the relevant month cell, in order to match against the overdue payable amount and month.

If the licensee has one or more instalments in respect of which there is a **legitimate dispute** at the assessment date, it must complete the disputes schedule as detailed in Section 6.1.2.3 above.

If a licensee has payables to social/tax authorities at the assessment date which have been **deferred** on the basis of an agreement in writing with the relevant social/tax authority, the licensee must disclose the following information:

- the name of relevant social/tax authority;
- the amount that is subject to deferral, and the month in which it was originally due to be paid to the social/tax authority (specifying amounts in each of the six months prior to the assessment date, and inputting any amounts older than six months in the "Older" cell); and
- the post deferrals due date(s) for the amount(s) to be paid to the social/tax authority, as per an agreement in writing with the social/tax authority.

For the avoidance of doubt, payables to social/tax authorities at the assessment date which were originally due to be paid before the assessment date can only be disclosed as deferred (rather than overdue payables) if the licensee has concluded an agreement which has been accepted in writing by the social/tax authority concerned that extends the due date beyond the applicable assessment date.

6.1.5. Summary output schedule

The summary output schedule is automatically populated from data input into other schedules in the OP package. The amounts in the summary output schedule are in euros, to enable comparisons between licensees.

The schedule summarises the disclosed payables at the assessment date (translated to euros) in respect of:

- transfer payables, categorised by "agreed transfer compensation", "conditional transfer compensation/joint and several liability" and "solidarity/training compensation";
- employee payables; and
- social/tax payables.

The table also separately identifies:

- the amount of overdue payables – analysed by
 - (i) amounts settled since the assessment date, and
 - (ii) overdue payables not settled since the assessment date;
- transfer amounts not overdue – analysed by:
 - (i) amounts that have been deferred by written agreement,
 - (ii) amounts in dispute, and
 - (iii) payables that are not due at the assessment date (and not subject to deferral or dispute).

6.1.6. Management representation

The licensee must validate the OP package prior to submission by completing the management representation schedule, certifying that:

- *"On behalf of the executive body of the licensee, we hereby certify that all possible care has been taken to ensure that the information entered in the CL/FFP IT Solution is clear, accurate, reliable and complete in accordance with the requirements included in the UEFA Club Licensing and Financial Fair Play Regulations, directives, toolkits and other information communicated to licensees."*

The licensee must check and confirm that for each player transfer in the transfer table schedule, the licensee has input the date on which the player’s registration has been transferred-in permanently or on loan.

The licensee’s management representative must be on the list of authorised signatories registered for club licensing.

The licensee should make the licensor aware of any unusual items contained in the package by entering a brief description in the box provided and/or describing any documentation attached to the package.

6.2. Responsibilities of licensors

6.2.1. Assessment procedures for the no overdue payables requirements

Refer to **Section 4.2.1** for the duties of the licensor.

To assess the completeness and accuracy of the information submitted in the payables schedules, as a minimum the licensor’s assessment procedures in respect of the no overdue payables requirements of Articles 65, 66 and 66bis are as follows:

Licensor assessment schedule – OP.06 / OP.09 packages	
Schedule	Licensor’s assessment procedures
Management representation schedule	<ul style="list-style-type: none"> Check that the licensee’s signatory in the management representation schedule is on the list of authorised signatories as already held for club licensing purposes.
Transfer table schedule	<ul style="list-style-type: none"> Compare the player details in the transfer table schedule with the information already disclosed to the licensor for the purpose of player registrations, to check that all professional players transferred-in from another club and registered between 1 July in the year preceding the assessment date and the assessment date have been disclosed in the transfer table schedule. “Player details” refers to the player’s name, identity of the former club, whether the player’s registration has been transferred-in permanently (“Transfer”) or temporarily (“Loan”), and the date of the transfer. Read the licensee’s completed transfer table schedule and make additional enquiries of the licensee if there is any information that may be incomplete and/or inaccurate based on the licensor’s existing knowledge of the licensee from club licensing and/or other reasonable information sources*.
Employee table schedule	<ul style="list-style-type: none"> Read the licensee’s completed employee table schedule and make additional enquiries of the licensee if there is any information that may be incomplete and/or inaccurate based on the licensor’s existing knowledge of the licensee from club licensing and/or other reasonable information sources*.
Social/tax table schedule	<ul style="list-style-type: none"> Read the licensee’s completed social/tax table schedule and make additional enquiries of the licensee if there is any information that may be incomplete and/or inaccurate based on the licensor’s existing knowledge of the licensee from club licensing and/or other reasonable information sources*.

* Examples of information sources include media reports, notifications of dispute cases, decision of a competent authority regarding termination of a contract by a player and correspondence from other football bodies, football clubs, the licensee’s directors and employees, and social/tax authorities.

APPENDIX I: KEY DATES AND DEADLINES FOR THE 2018/19 MONITORING PROCESS

Deadlines for licensees/licensors to submit the required club monitoring information to the UEFA administration via the CL/FFP IT Solution are the following:

Date	Description
27 April 2018	<p><u>Scope:</u> Top division clubs (as a minimum, all licence applicants)</p> <ul style="list-style-type: none"> • FS.2018.01 package covering financial data for the entities in the licence applicants' reporting perimeter for the financial reporting period ending in 2017 (i.e. being the reporting period T-1 for the 2018/19 licence season).
30 June 2018	Key date for the assessment of the no overdue payables requirements.
[tbd] June/July 2018	<p>Deadline for the licensee to submit validated monitoring documentation to the licensor as described in the following step.</p> <p>Note: Submission deadline for licensees to be defined ("tbd") by the licensor</p>
16 July 2018	<p><u>Scope:</u> All clubs participating in the 2018/19 UEFA club competitions</p> <p>Deadline for the licensor to submit to the UEFA administration the licensee's monitoring documentation and to confirm that the licensor's assessment procedures have been completed. The licensee's documentation includes:</p> <ul style="list-style-type: none"> • CI - 2018.01 package covering the club/ information for reporting periods ending in 2016 (T-2), 2017 (T-1) and 2018 (T)⁽¹⁾; • OP - 2018.06 package covering no overdue payables information as at 30 June 2018 including Transfer, Employee and Social/tax payables information; and • BE - 2018.06 package covering break-even information for the reporting periods ending in 2016 (T-2) and 2017 (T-1). <p>Note ¹: Any subsequent changes to the legal group structure and/or reporting perimeter information in respect of reporting period T must be resubmitted to the UEFA administration by 15 October 2018 as part of the CI package. The licensee has an ongoing obligation to promptly notify its licensor about any subsequent changes.</p>
[tbd] September 2018	<p><u>Scope:</u> Licensees as requested by UEFA administration</p> <p>If requested, the licensee must submit player transfer balance information in respect of a player registration period ending during the licence season.</p>
30 September 2018	<p>Key date for the additional assessment of the no overdue payables requirements. ⁽²⁾</p> <p>Note ². Only applicable to licensees who had overdue payables at 30 June 2018, or if otherwise requested by CFCB.</p>
[tbd] October 2018	<p>For those licensees required to comply, deadline⁽³⁾ for the licensee to submit validated monitoring documentation to the licensor as described in the following step.</p> <p>Note ³: Submission deadline for licensees to be defined ("tbd") by the licensor.</p>
15 October 2018	<p><u>Scope:</u> All clubs participating in the 2018/19 UEFA club competitions which are in breach of an Article 62 indicator (for "BE.2018.09" package) or have overdue payables as at 30 June 2018 (for OP.2018.09 package), or if otherwise requested by the CFCB</p> <p>Deadline for the licensor to submit to the UEFA administration the licensee's monitoring documentation and to confirm that the licensor's assessment procedures have been completed. The licensee's documentation includes:</p> <ul style="list-style-type: none"> • OP - 2018.09 package covering no overdue payables information as at 30 September 2018 including Transfer, Employee and Social/tax payables information; and • BE - 2018.09 package covering: <ul style="list-style-type: none"> • <u>For clubs with reporting period T ending on or before 31 July 2018</u> <ul style="list-style-type: none"> ○ break-even information for the reporting period ending in 2018 (T) based on audited annual financial statements;

Date	Description
	<ul style="list-style-type: none"> ○ the projected break-even information for the reporting period ending in 2019 (T+1); and ○ if applicable, break-even information for reporting periods ending in 2015 and/or 2014 (T-3 and T-4). <p><i>For clubs with reporting period T ending after 31 July 2018 (no later than 31 Dec 2018)</i></p> <ul style="list-style-type: none"> ○ break-even information for the reporting period ending in 2018 (T) based on unaudited annual financial statements; and ○ if applicable, projected break-even information for the reporting period ending in 2019 (T+1)
<p>[tbd] February 2019</p>	<p><u>Scope:</u> Licensees as requested by UEFA administration</p> <p>If requested, the licensee must submit player transfer balance information in respect of a player registration period ending during the licence season.</p>
<p>[tbd] March 2019</p>	<p>For those licensees which first submitted break-even information for their reporting period ending 2018 (T) based on unaudited financial statements, deadline⁽⁴⁾ for the licensee to submit validated updated monitoring documentation to the licensor as described in the following step.</p> <p>Note ⁴: Submission deadline for licensees to be defined (“tbd”) by the licensor.</p>
<p>15 March 2019 <i>(if applicable)</i></p>	<p><u>Scope:</u> All clubs participating in the 2018/19 UEFA club competitions which submitted unaudited annual financial statements as of 15 October 2018 or are in breach of an indicator</p> <p>Deadline for the licensor to submit to the UEFA administration the licensee’s updated monitoring documentation and to confirm that the licensor’s assessment procedures have been completed. The licensee’s documentation includes:</p> <ul style="list-style-type: none"> ● BE - 2018.09 package covering: <ul style="list-style-type: none"> ○ break-even information for the reporting period ending in 2018 (T) based on audited annual financial statements; ○ the projected break-even information for the reporting period ending in 2019 (T+1); and ○ if applicable, break-even information for the reporting periods ending in 2015 and/or 2014 (T-3 and T-4).
<p>1 May 2019</p>	<p>Deadline for submitting to the UEFA administration:</p> <ul style="list-style-type: none"> ● FS.2019.01 package in the CL/FFP IT Solution, including financial data⁽⁵⁾ for the entities in the licensee’s reporting perimeter for their financial reporting period ending in 2018. <p>Note ⁵: For those licensees that have already submitted break-even information for their reporting period ending 2018 based on audited financial statements, their FS.2019.01 package will be pre-populated.</p>
<p>31 May 2019</p>	<p>End of the 2018/19 licence season.</p>

APPENDIX II: THE LINKAGE BETWEEN THE FS PACKAGE AND THE BE PACKAGES

For those licensees that become subject to club monitoring in the following licence season, the information that has been input into the FS package for the profit and loss account, balance sheet and cash flow statement will pre-populate some elements of the BE.06 package for reporting period T-1, and in some cases T-2.

If a licensee has been subject to club monitoring in the previous season, then information that has previously been input into the BE.06 package and BE.09 package (if applicable) will pre-populate some elements of the BE.06 and BE.09 packages.

For the avoidance of doubt, whenever a BE package is pre-populated, a licensee must still check the completeness and accuracy and update the information accordingly, plus input supplementary information and adjustments information (as applicable), prior to submission.

For some licence applicants, the FS package itself will be pre-populated from information input into the preceding BE.09 package.

The scenarios below illustrate the profit and loss account, balance sheet and cash flow statement information flows between the FS package and the BE packages, and between the BE packages, for the licence seasons 2016/17, 2017/18 and 2018/19.

Scenario 1: The first season the licensee competed in a UEFA competition was the 2018/19 season (it was not in UEFA competitions in the 2016/17 or 2017/18 seasons). The licensee had to complete the BE.2018.09 package, but opted not to include the break-even results from T-3 and T-4.

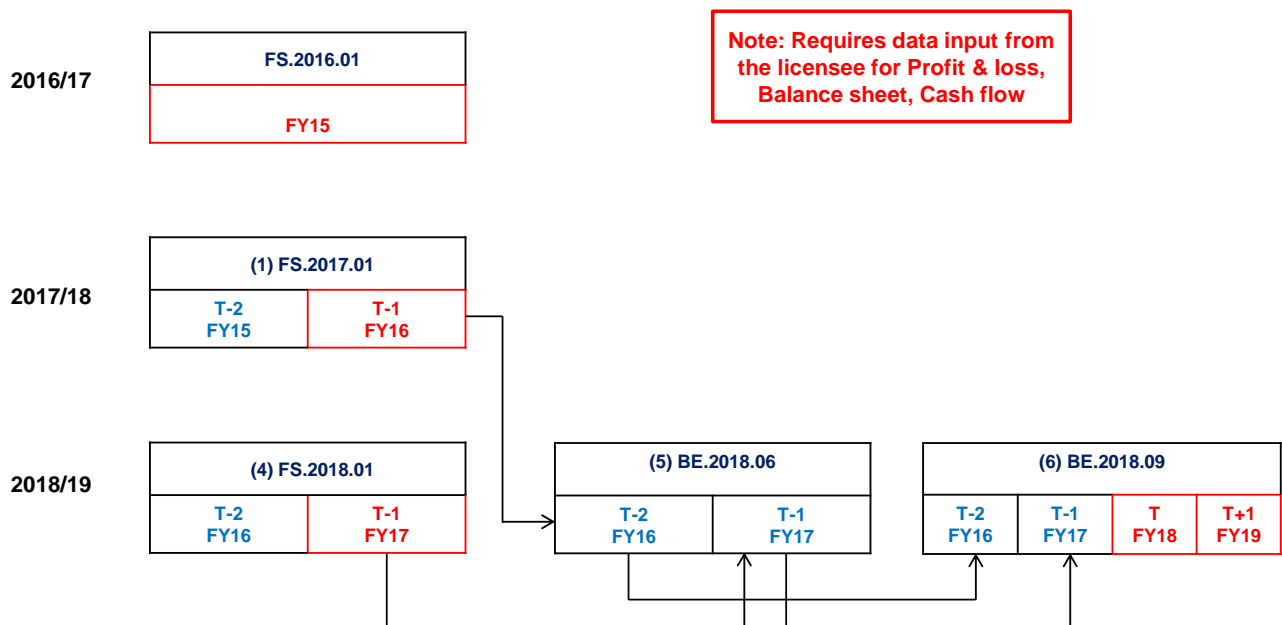

Steps (1), (4), (5) and (6) are explained at the end of this Appendix

Steps (2) and (3) not applicable as the licensee did not compete in a UEFA competition in the 2017/18 licence season

Scenario 2: The first season the licensee competed in a UEFA competition was the 2017/18 season. It also competed in the 2018/19 season. The licensee was not in breach of indicators and therefore not required to complete the BE.2017.09 or BE.2018.09 packages.

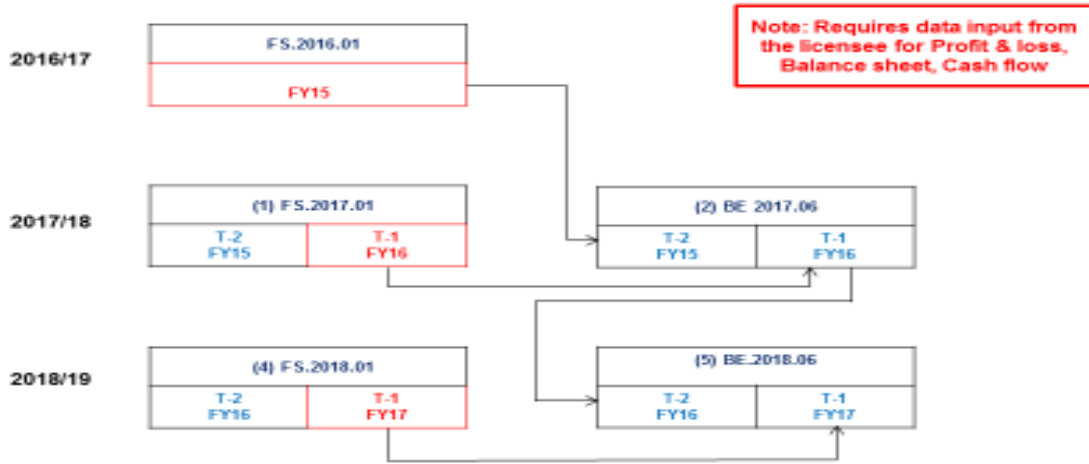

Steps (1), (2), (4) and (5) are explained at the end of this Appendix
 Steps (3) and (6) are not applicable, as the licensee is not required to complete the BE.09 package.

Scenario 3: The first season the licensee competed in a UEFA competition was the 2016/17 season. It was also in UEFA competitions in the 2017/18 and 2018/19 seasons, and was required to complete the BE.09 package in each licence season. The licensee has opted not to include the break-even results from T-3 and T-4 in the BE2018.09 package.

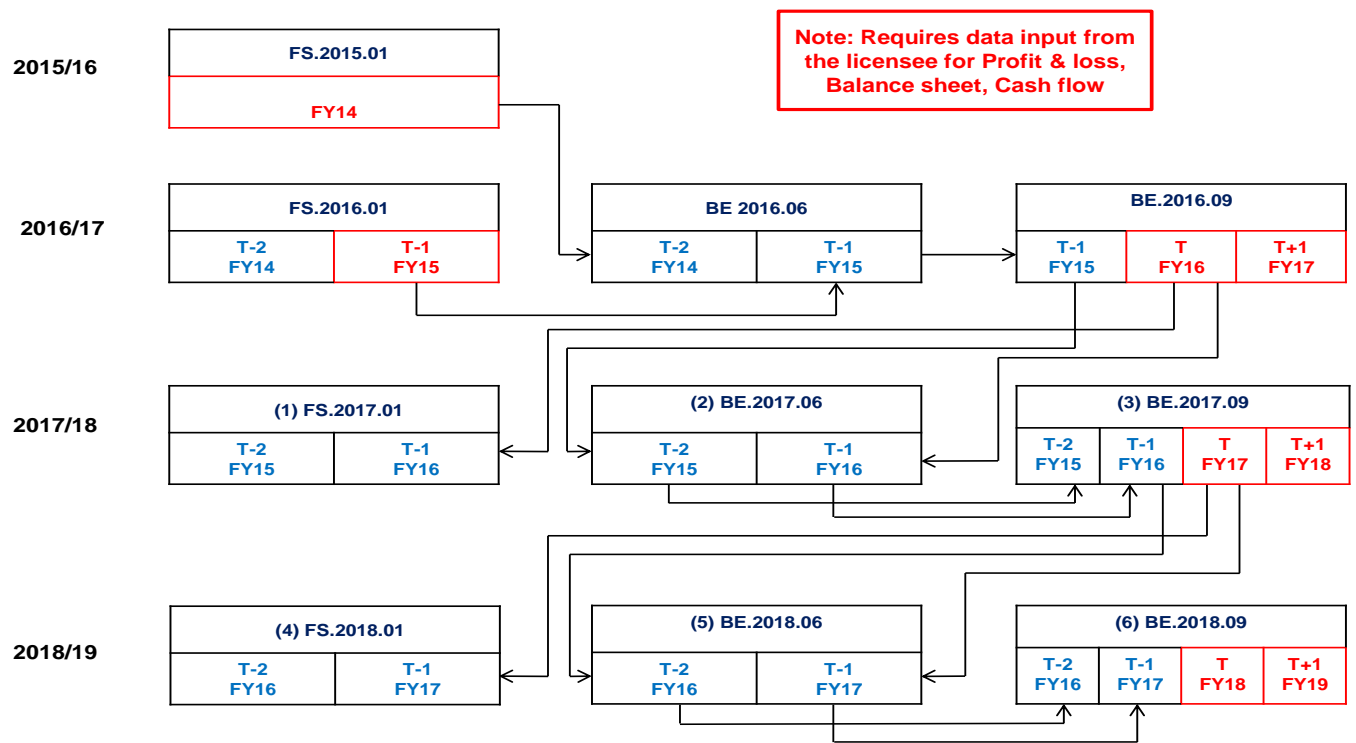

Steps (1) to (6) are explained at the end of this Appendix

Steps

- (1) Ahead of licence season 2017/18, all licence applicants were required to submit financial information in the FS.2017.01 package for their reporting period ending 2016 (i.e. FY16) and submit it, via their licensor, to the UEFA administration by 30 April 2017. For some licence applicants, as shown in Scenario 3, the required information may have been pre-populated following completion of the BE.2016.09 package.
- (2) For the licence season 2017/18, the licensee must submit break-even information for FY15 (T-2) and FY16 (T-1) in BE.2017.06. This information may have been pre-populated from previous submissions, as shown in Scenarios 2 and 3. In Scenario 2 the information was partially pre-populated from the FS.2016.01 and FS.2017.01 packages, but the licensee had to complete any missing information, such as the adjustment schedules. The licensee was required to submit the full requirements of the BE.2017.06 package.
- (3) For those licensees required to also submit the BE.2017.09 package, the information from the BE.2017.06 package (step 2) for FY15 and FY16 pre-populated the corresponding schedules in the BE.2017.09 package for reporting periods T-2 and T-1. The licensee was required to submit the full requirements of the BE.2017.09 package, including the financial information for their reporting period ending 2017 (T) and projected break-even information for reporting period ending 2018 (T+1).
- (4) Ahead of licence season 2018/19 (by the set deadline), all licence applicants were required to submit financial information in the FS.2018.01 package for FY17. This was pre-populated from the BE.2017.09 package for those licensees that were required to complete it (step 3). Those licensees which were not required to complete BE.2017.09 will need to input this FY17 information (i.e. as in Scenarios 1 and 2).
- (5) For the licence season 2018/19, the licensee must submit break-even information for FY16 (T-2) and FY17 (T-1) in BE.2018.06. This information will be pre-populated from the corresponding schedules in the BE.2017.06 package and BE.2017.09 package (if completed) (as in scenarios 2 and 3), and in some cases from previous submissions of FS package (as in scenarios 1 and 2). The licensee must submit the full requirements of the BE.2018.06 package.
- (6) For those licensees required to prepare and submit the BE.2018.09 package, the information for FY16 and FY17 will be pre-populated from the BE.2018.06 package (step 5) into the corresponding schedules in the BE.2018.09 package, covering reporting periods T-2 and T-1. The licensee must submit the full requirements of the BE.2018.09 package, including the financial information for the reporting period ending 2018 (T) and the projected break-even information for the reporting period ending 2019 (T+1). The licensee may opt to

take account of break-even information for reporting periods T-3 and T-4, which may be pre-populated from previous BE packages.

APPENDIX III: GUIDANCE FOR CI PACKAGE – GROUP STRUCTURE AND REPORTING PERIMETER

A. The legal group structure – Article 46

For club monitoring purposes, the licensee must attach the legal group structure document(s) to the CI package (including the reporting perimeter as defined in Article 46bis, clearly identified on the document) in respect of reporting period T and, if different, for T-1 and T-2 – presented in a chart/diagram and duly approved by its management. For T-1, this same documentation also had to be submitted to the licensor for the immediately preceding club licensing requirements.

In accordance with Article 46(2), **the legal group structure document** must clearly identify and include information on the entities/persons set out in (a) to (g) below (and must also clearly identify the reporting perimeter as defined in Article 46bis):

a) The licence applicant/licensee and, if different, the registered member of the UEFA member association.

b) Any subsidiary entity of the licence applicant/licensee and, if different, the registered member of the UEFA member association.

A **subsidiary** is an entity that is controlled by another entity (known as a parent entity). **Control** is the power to govern the financial and operating policies of an entity so as to obtain benefits from its activities. **Control may be gained** by share ownership (e.g. more than 50% ownership/voting rights), via statutes or agreements (e.g. contractual arrangements).

The legal group structure document must include any subsidiary of a subsidiary.

c) Any associate entity of the licence applicant/licensee and, if different, the registered member of the UEFA member association.

An **associate** is an entity over which an investor entity has significant influence.

d) Any direct or indirect controlling entity of the licence applicant/licensee, up to and including the ultimate controlling party.

A **direct controlling entity** is an immediate parent entity of the licence applicant/licensee. An **indirect controlling entity** is a parent entity of an immediate parent entity of the licence applicant/licensee.

The **ultimate controlling party** (of the licence applicant/licensee and, if different, the registered member of the UEFA member association) is the person or legal entity that ultimately controls the entity.

The ultimate controlling party will usually be one of the following:

- a person;
- an association (e.g. members club);
- a foundation (e.g. an entity governed by trustees);
- a limited company (e.g. a non-listed company or a listed company), only if there is no controlling shareholder of such company; or
- a government (e.g. a government agency, government department, or sovereign wealth fund).

If a licensee has no ultimate controlling party, then this must be disclosed.

e) Any party that has 10% or greater direct or indirect ownership of the licence applicant, or 10% or greater voting rights;

The legal group structure document must disclose:

- Any person or legal entity which owns 10% or more of the licence applicant/licensee's shares (i.e. direct ownership) or its voting rights.

- Any person or legal entity which has a 10% or more indirect ownership of the licence applicant/licensee's shares or its voting rights, through its shareholding in a parent entity of the licence applicant/licensee. For example, if Person X owns 40% of Entity A and Entity A owns 75% of the licence applicant/licensee, then Person X has indirect ownership of 30% and, therefore, must be disclosed in the legal group structure document.

f) any party with a significant influence over the licence applicant/licensee.

Significant influence may be gained by share ownership (e.g. more than 20% ownership/voting rights), statutes or other means (e.g. contractual arrangements). In addition, a party or aggregate parties with the same ultimate controlling party (excluding UEFA, a UEFA member association or an affiliated league) is deemed to have significant influence if it provides an amount equivalent to 30% or more of the licensee's total revenue in a reporting period.

g) any other football club, in respect of which any of the parties identified in (a) to (f) or any of their key management personnel have any **ownership interest, voting rights, and/or any involvement or influence** whatsoever in relation to the governance of its financial and operating policies.

If deemed relevant, the licensor and/or CFCB may ask the licence applicant/licensee to provide information about additional persons and/or entities not otherwise included on the legal group structure document. For example, any other subsidiary or associate of a direct controlling entity, indirect controlling entity, or ultimate controlling entity of the licence applicant/licensee.

Illustration of legal group structure

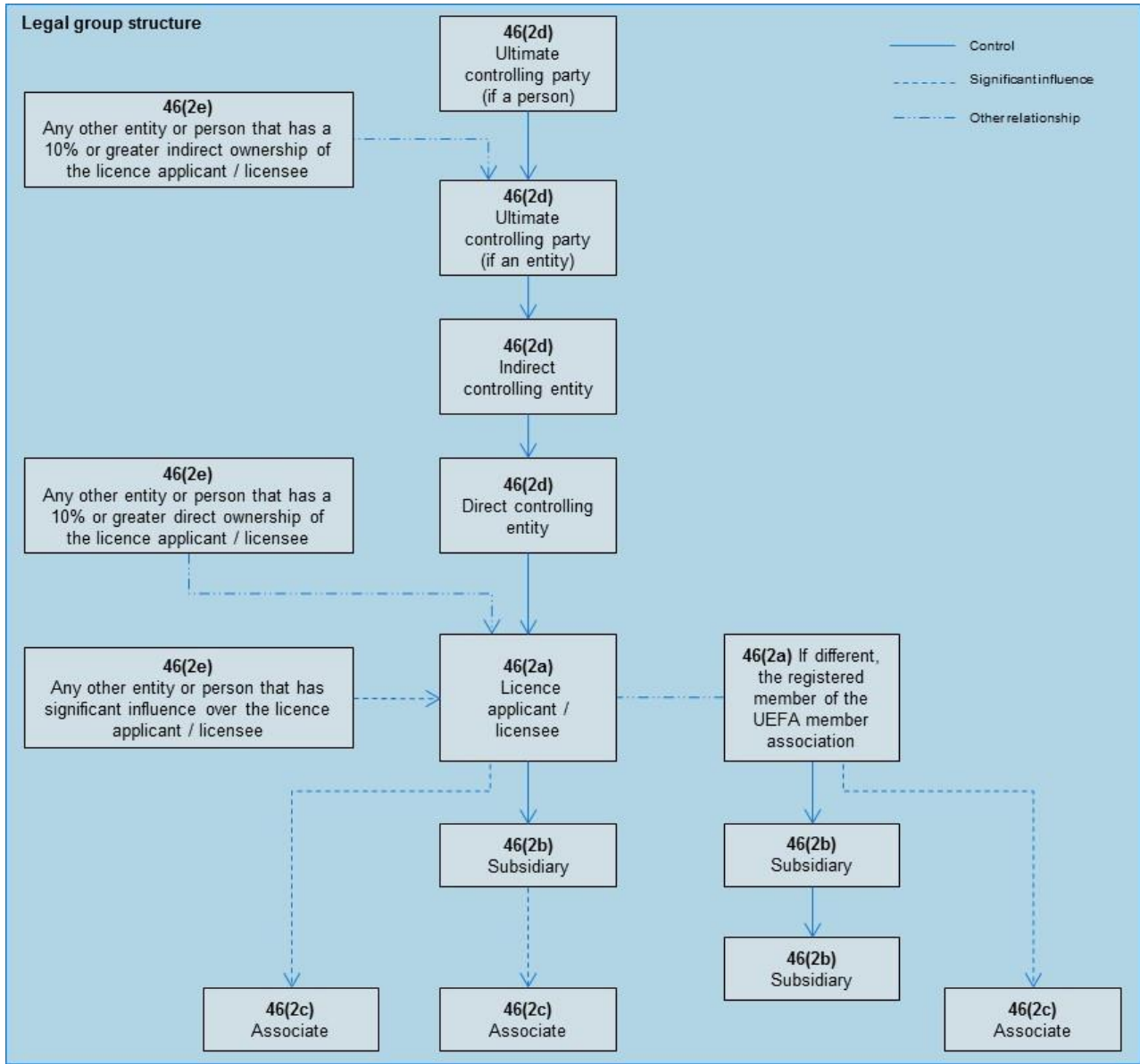

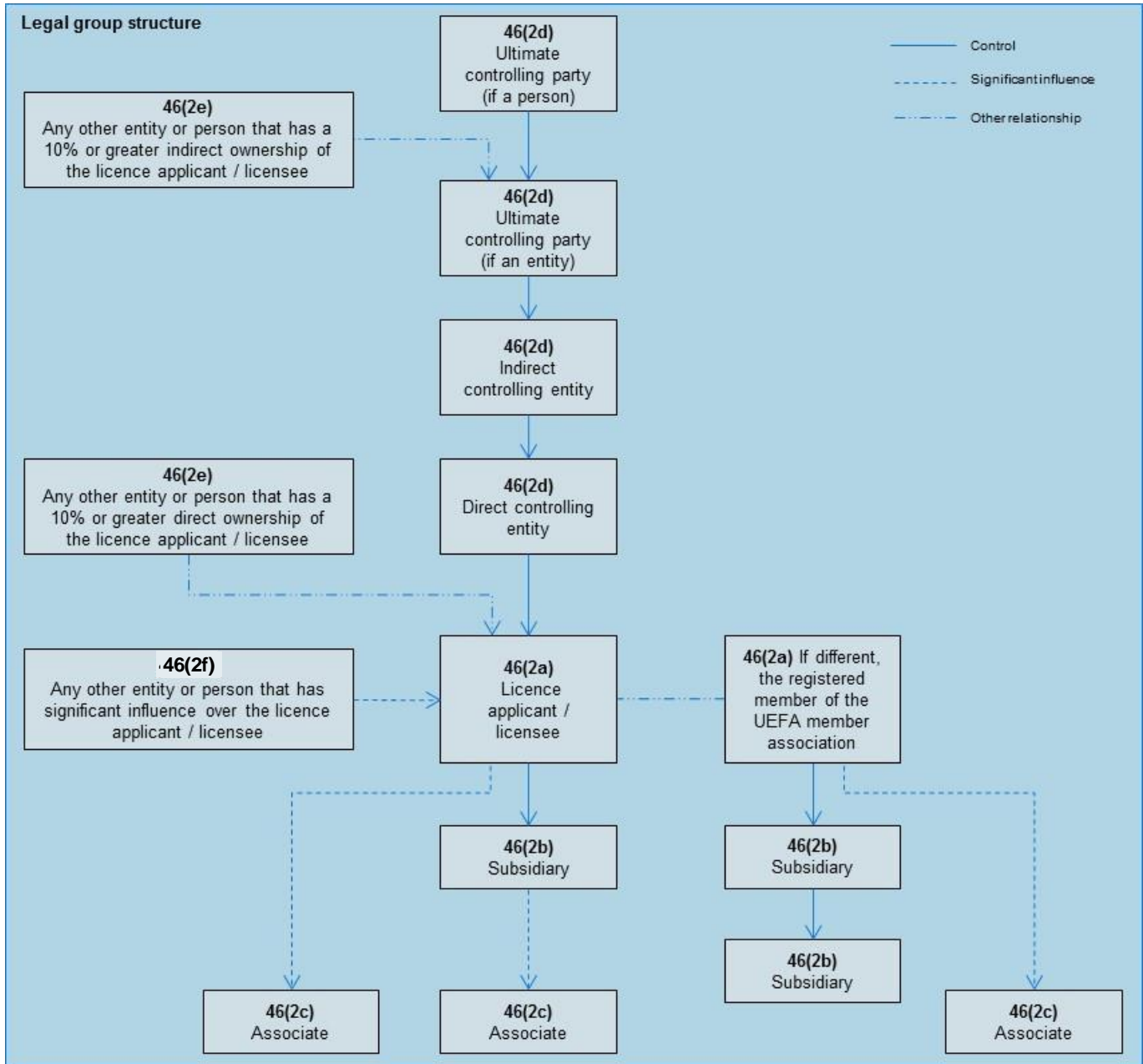

Note: Per Article 46(2g), if applicable, the legal group structure must disclose any other football club, in respect of which any of the parties identified on the legal group structure, or any of their key management personnel, have any ownership interest, voting rights and/or any involvement or influence whatsoever in relation to the governance of its financial and operating policies.

B. The reporting perimeter – Article 46bis

As set out in Article 46bis, the **reporting perimeter** is the entity or combination of entities in respect of which financial information must be prepared and submitted for the purposes of club licensing and club monitoring.

For club monitoring, a licensee must use the same reporting perimeter for the preparation and submission of financial information for each of the requirements (i.e. for each of the break-even requirement and the no overdue payables requirements) and it must also be the same reporting perimeter as used to fulfil the club licensing criteria, unless there has been a change of circumstances.

In accordance with Article 46bis(2), **the reporting perimeter must include:**

- the licence applicant/licensee and, if different, the registered member of the UEFA member association;
- any subsidiary entity of the licence applicant/licensee and, if different, the registered member of the UEFA member association;

- c) any other entity included in the legal group structure which generates revenues and/or performs services and/or incurs costs in respect of the football activities as defined in Article 46bis(3c to 3k):
- ticketing,
 - sponsorship and advertising,
 - broadcasting,
 - merchandising and hospitality,
 - club operations (e.g. administration, matchday activities, travel, scouting, etc.),
 - financing (including financing secured or pledged against the assets of the licence applicant),
 - use and management of stadium and training facilities;
 - women's football; and
 - youth sector;
- d) any entity, irrespective of whether it is included in the legal group structure, which generates revenues and/or performs services and/or incurs costs in respect of football activities as defined in Article 46bis(3a and 3b):
- employing/engaging personnel (as defined in Article 50) including payment of all forms of consideration to employees arising from contractual or legal obligations; and
 - acquiring/selling player registrations (including loans).

In accordance with Article 46bis(4), **an entity listed under Article 46(2b to 2e) may be excluded from the reporting perimeter only if:**

- a) Its activities are entirely unrelated to the football activities (as defined in Article 46bis(3)) and/or the locations, assets or brand of the football club.
- With regard to Article 46bis(4a), for an entity to be excluded from the reporting perimeter it must meet all the conditions demonstrating that its activities are entirely unrelated to: (i) the football activities defined in Article 46bis(3); (ii) the locations of the football club (i.e. the activities are not physically based at or in close proximity to the club's home stadium or training facilities); (iii) the assets of the football club; and (iv) the brand of the football club (i.e. the entity does not use the name/brand of the club as part of its operations at the location and in customer/marketing collateral); or
- b) It is immaterial compared with all the entities that form the reporting perimeter and it does not perform any of the football activities defined in Article 46bis(3a and/or 3b), being football activities for employing/engaging personnel (as defined in Article 50), including payment of all forms of consideration to employees arising from contractual or legal obligations and/or acquiring/selling player registrations (including loans); or
- c) The football activities it performs are already entirely reflected in the financial statements of one of the entities included in the reporting perimeter (e.g. employee benefit expenses for employees involved in generating sponsorship revenues for the football club are already recorded in an entity in the reporting perimeter by way of intra-group recharges).

Depending on the situation of each licensee, **the reporting perimeter will comprise** either:

- i) **solely the licence applicant/licensee (single entity)**, as the entity which is the registered member of the UEFA member association and/or its affiliated league, for which financial information is prepared covering solely the single reporting entity; or
- ii) **a group of two or more entities (consolidation)**, including the licence applicant and, if different, the registered member entity, for which financial information is prepared on a consolidated basis as if they were a single company; or
- iii) **two or more entities (combination)**, including the licence applicant and, if different, the registered member entity, for which financial information is prepared on a combined basis as if they were a single company.

Illustrative examples

Example 1

The legal group structure:

- Entity B is the licence applicant and registered member of a UEFA member association and/or its affiliated league.
- Entity A is the direct controlling entity of Entity B. Entity A has football activities.
- Person X is the ultimate controlling party of Entity A and Entity B.
- Entity C is a subsidiary of Entity B and has football activities.
- Entity D is a subsidiary of Entity B and has football activities.

In addition to the licence applicant (Entity B), the reporting perimeter must include:

- Entity A, as per Art. 46bis(2c/d), because Entity A generates revenues and/or performs services and/or incurs costs in respect of football activities; and
- Entities C and D, as per Art. 46bis(2b), because Entities C and D generate revenues and/or perform services and/or incur costs in respect of football activities.

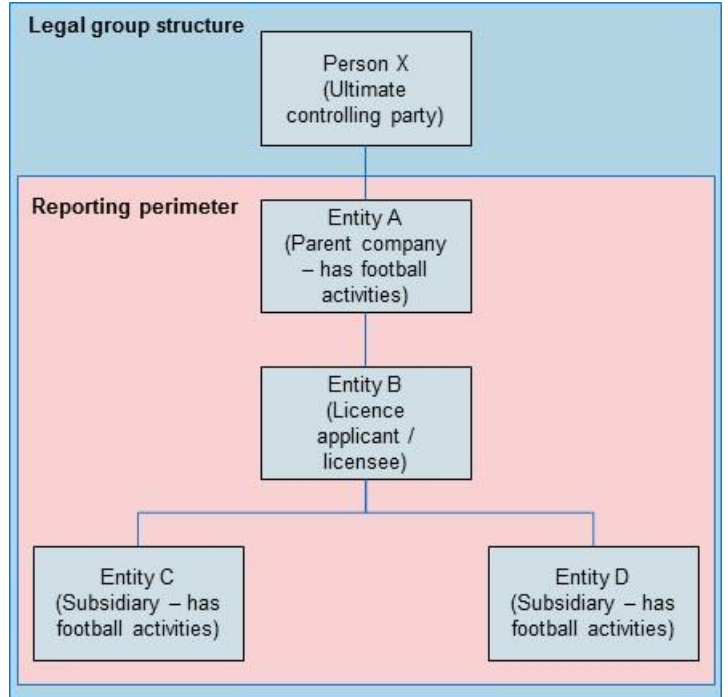

Note: Financial statements will be prepared on a consolidated basis.

Example 2

The legal group structure:

- Entity B is the licence applicant and has a contractual relationship with Entity A. As per Article 12, Entity B is described as 'a football company'.
- Entity A is the registered member of a UEFA member association and/or its affiliated league.
- Person X is the ultimate controlling party of Entity B.
- Entity C is a subsidiary of Entity B and has football activities.

In addition to the licence applicant (Entity B), the reporting perimeter must include:

- Entity A, as per Art. 46bis(2a); and
- Entity C, as per Art. 46bis(2b), because Entity C generates revenues and/or performs services and/or incurs costs in respect of football activities.

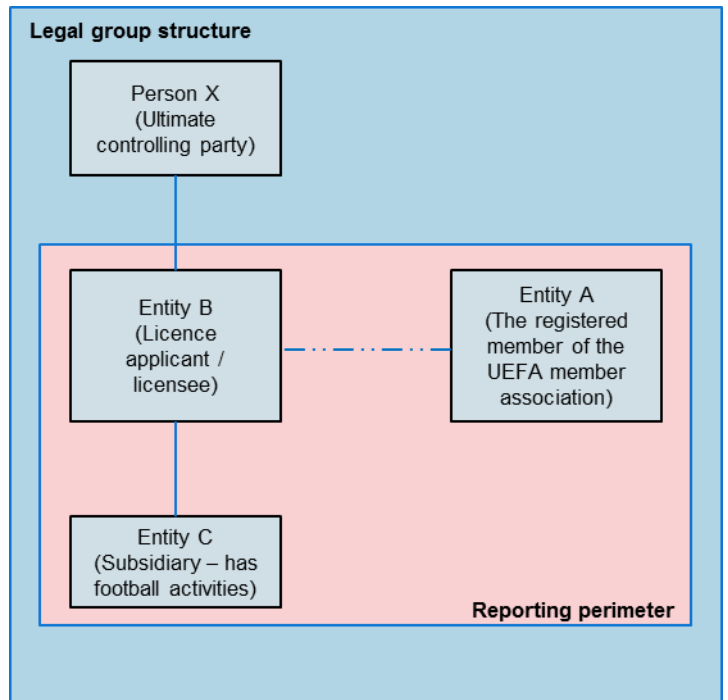

Note: Financial statements will be prepared on a combined basis.

Example 3

The legal group structure:

- Entity B is the licence applicant and registered member of a UEFA member association and/or its affiliated league.
- Entity A is the direct controlling entity of Entity B. Entity A has no football activities.
- Person X is the ultimate controlling party of Entity A and Entity B.
- Entity C is a subsidiary of Entity B and has football activities.
- Entity D is a subsidiary of Entity B. Entity D is dormant.

In addition to the licence applicant (Entity B), the reporting perimeter must include:

- Entity C, as per Art. 46bis(2b), because Entity C generates revenues and/or performs services and/or incurs costs in respect of football activities.

The reporting perimeter may exclude Entity D, as per Art. 46bis(4b), because Entity D does not perform any of the football activities defined in Art. 46bis(3a/b).

Alternatively, Entity D may be included in the reporting perimeter, and then the licensee must consider if adjustments are required for the break-even calculation under Annex X (B11 / C1m).

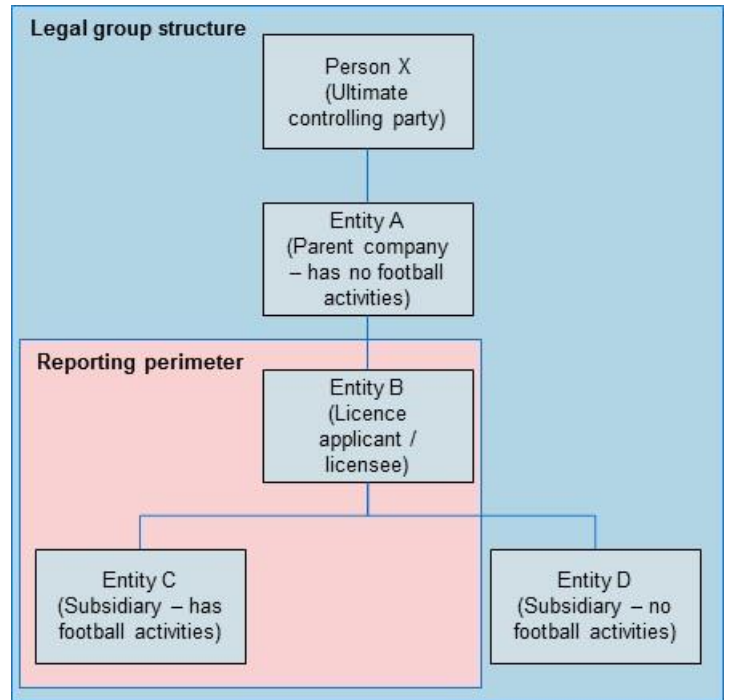

Note: If Entity D is excluded from the reporting perimeter, then financial statements will be prepared on a combined basis. Alternatively, if Entity D was included in the reporting perimeter, then financial statements will be prepared on a consolidated basis.

Example 4

The legal group structure as per Article 46:

- Entity B is the licence applicant and registered member of a UEFA member association and/or its affiliated league.
- Entity A is the direct controlling entity of Entity B and includes football activities (e.g. employees involved in sponsorship activities for the football club).
- Person X is the ultimate controlling party of Entity A and Entity B.
- Entity C is a subsidiary of Entity B and has football activities.

Notes: Entity D is a subsidiary of Entity A and, prima facie, does not need to be disclosed in the legal group structure as per Article 46. However, Entity D performs services and incurs costs in respect of football activities as defined in Art. 46bis(3a/b) and such costs have not already been reflected in the financial statements of Entity A, B or C.

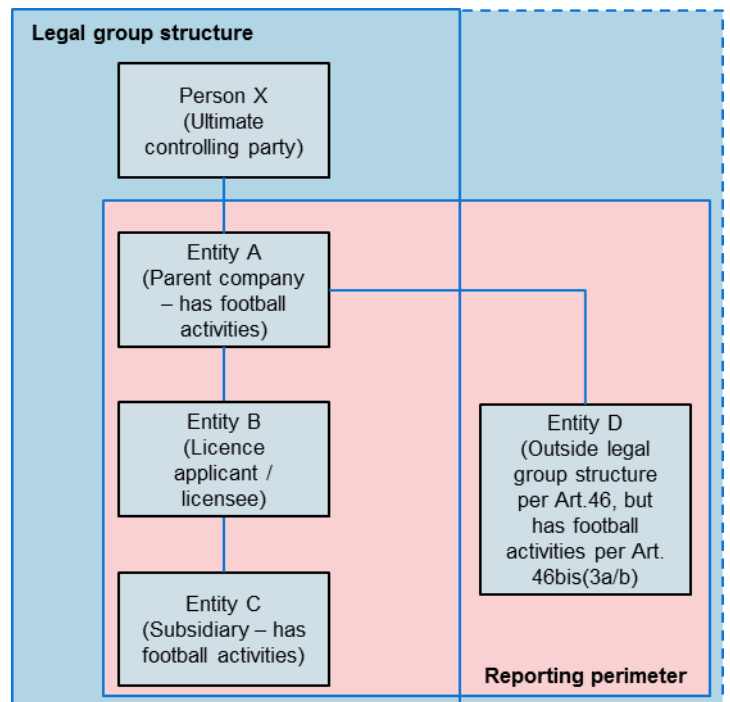

Note: Financial statements will be prepared on a consolidated basis.

In addition to the licence applicant (Entity B), the reporting perimeter must include:

- Entity A, as per Art. 46bis(2c/d), because Entity A generates revenues and/or performs services and/or incurs costs in respect of football activities;
- Entity C, as per Art. 46bis(2b), because Entity C generates revenues and/or performs services and/or incurs costs in respect of football activities.; and
- Entity D, as per Art. 46bis(2d).

C. Consolidation / combination requirements – Annex VII

The steps involved in creating combined or consolidated financial statements are basically the same. The major difference between consolidated financial statements and combined financial statements has to do with the ownership of the entities involved.

In situations where the reporting perimeter includes a **group**, whereby a parent company has controlling interest in one or more subsidiary companies, the licence applicant must **consolidate** the financial results and position of the parent and the subsidiaries into one set of financial statements. The rationale behind this requirement is that because these companies are all operating together as a single enterprise, they should report their results as though they were a single company.

In situations where the reporting perimeter has multiple entities operating as a single company even though there is no parent-subsidiary relationship between them, the licence applicant must **combine** the financial results and position of the entities into one set of financial statements. In this case, although there is no international and national accounting practice requirement to do so, the Regulations require the financial statements of the entities to be combined in order to get an appropriate overall picture.

The preparation and presentation of consolidated and combined financial statements are largely the same. There are more similarities than differences between combined and consolidated statements. In both cases, intercompany transactions are eliminated and minority interests are presented the same way. However, equity accounts are typically adjusted in consolidated statements (to not duplicate ownership balances), whereas in combined statements, equity accounts are typically added together (unless the companies have ownership in each other).

APPENDIX IV: GUIDANCE FOR FS & BE PACKAGES – INPUT SCHEDULES

A. Balance sheet – Annex VI B

The balance sheet presents the financial position for the licensee’s reporting perimeter, which is the relationship between the assets, liabilities and equity as at the end date of a reporting period. The licensee must prepare and submit balance sheet information in the prescribed format in the CL/FFP IT Solution, based on the annual financial statements, supplementary information and underlying accounting records.

Figures must be input into the balance sheet schedule as follows:

- in the licensee’s presentation currency;
- rounded to the nearest thousand (e.g. €1,234,567 should be entered as €1,235);
- all items must be input **as positive figures**.

Balance Sheet	T-1
Current Assets	
Cash and cash equivalents	
Accounts receivable from player transfers	
Accounts receivable from group entities & related parties	
Other accounts receivable	
Tax assets	
Inventories	
Other current assets	
Total Current Assets	
Non-Current Assets	
Tangible fixed assets	
Intangible assets - players	
Intangible assets - other	
Accounts receivable from player transfers	
Accounts receivable from group entities & related parties	
Tax assets	
Investments	
Other non-current assets	
Total Non-Current Assets	
Total Assets	
Current Liabilities	
Bank overdrafts	
Bank and other loans	
Loans/Accounts payable to group entities & related parties	
Accounts payable relating to player transfers	
Accounts payable to employees	
Accounts payable to social / tax authorities	
Accruals and deferred income	
Other accounts payable	
Other tax liabilities	
Short-term provisions	
Other Current Liabilities	
Total Current Liabilities	
Non-Current Liabilities	
Bank and other loans	
Loans/Accounts payable to group entities & related parties	
Accounts payable relating to player transfers	
Accounts payable to employees	
Accounts payable to social/tax authorities	
Deferred income	
Other tax liabilities	
Long-term provisions	
Other Non-current liabilities	
Total Non-Current Liabilities	
Total Liabilities	
Net Assets/(Liabilities)	

Equity	
Share/fund capital	
Retained earnings	
Other Reserves	
Total Equity	
Total Equity and Total Liabilities	

1. Current assets and non-current assets

An asset is classified as current when it satisfies any of the following criteria:

- it is expected to be realised, sold or consumed in the entity's normal operating cycle;
- it is held primarily for the purpose of being traded;
- it is due to be realised within 12 months after the balance sheet date; or
- the asset is cash or cash equivalent, unless it is restricted from being exchanged or used to settle a liability for at least 12 months after the balance sheet date.

All other assets are classified as non-current.

Cash and cash equivalents

- Cash comprises cash on hand and demand deposits. Cash equivalents are short-term, highly liquid investments that are readily convertible to known amounts of cash and which are subject to an insignificant risk of changes in value.

Accounts receivable from player transfers

- Amounts receivable in respect of the transfer of a player's registration (including training compensation and solidarity contributions).

Accounts receivable from group entities and other related parties

- Amounts receivable from group entities are amounts receivable from other entities that are under common control, including parents, subsidiaries and fellow subsidiaries. Other related parties are as defined in Annex X F.

Other accounts receivable

- These include trade and other receivables (such as trade debtors, other debtors, prepayments, accrued income), other than those categorised separately as receivable from player transfers and/or from group entities and other related parties.

Tax assets

- Tax assets are the amount of income taxes recoverable in future periods.

Inventories

- These are goods held for resale, such as replica football shirts and other club merchandise.

Other current assets

- These include current assets not otherwise included in one of the other balance sheet lines.
- This balance sheet line may include non-current assets held for sale for which relevant accounting standards prescribe required accounting treatment. Note that placing a player on the transfer list and/or disposal of a player's registration post year end will not, in themselves, be sufficient evidence to qualify as an asset held for sale.

Tangible fixed assets

- Tangible fixed assets refer to the balance of capitalised costs and associated depreciation/impairment in respect of property, plant and equipment.

Intangible assets – players

- If the licensee's accounting policy is to capitalise and amortise the direct costs of obtaining player registrations (rather than expense them in the year of acquisition), the intangible assets are the unamortised balance of these capitalised costs. This balance should be zero for any reporting entity whose accounting policy is to expense all the direct costs of obtaining player registrations in the year of acquisition.
- In accordance with Annex VII C (3b), locally trained players must not be included in the balance sheet as only the cost of the players purchased is to be capitalised.
- Some licensees will be required to disclose supplementary information in the "player identification table", to reconcile the aggregated net book value of player registrations to the amount in the balance sheet. For further guidance, see Appendix IV A.4

Intangible assets – other

- An intangible asset is an identifiable non-monetary asset without physical substance. It includes all intangible assets other than intangible assets relating to player registrations (e.g. goodwill).

Investments

- Investments include investments by the entity in subsidiaries, jointly controlled entities and associates.

Other non-current assets

- These include non-current assets not otherwise included in one of the other balance sheet lines.

2. Current liabilities and non-current liabilities

A liability is classified as current when it satisfies any of the following criteria:

- it is expected to be settled during the entity's normal operating cycle;
- it is held primarily for the purpose of being traded;
- it is due to be settled within 12 months after the balance sheet date; or
- the entity does not have an unconditional right to defer settlement of the liability for at least 12 months after the balance sheet date.

All other liabilities are classified as non-current.

Bank overdrafts

- A bank overdraft is a type of borrowing facility with a bank.

Bank and other loans

- Loans in current liabilities are defined as loans (not from related parties), or parts thereof, which are due to be settled within 12 months after the balance sheet date, for example, loans from banks or other commercial lenders.
- Non-current loans are defined as loans (not from related parties), or parts thereof, which are due to be settled more than 12 months after the balance sheet date – and are to be included under non-current liabilities.
- Lease liabilities should be included within bank and other loans.
- Lease liabilities should be classified as current or non-current loans based on the total minimum lease payments at the balance sheet date for the following periods not later than one year and later than one year.

Loans/accounts payable to group entities and other related parties

- Accounts payable and loans owed to group entities are amounts payable to other entities that are under common control, including parents, subsidiaries and fellow subsidiaries. Other related parties are as defined in Annex X, F.

Accounts payable relating to player transfers

- These are amounts payable as a result of transfer activities (including training compensation and solidarity contributions).
- Such liabilities are classified as current or non-current based on the total minimum payments at the balance sheet date for the following periods not later than one year and later than one year.
- If the licensee enters into some other form of financing arrangement with another party in respect of a player for whom it holds the registration, amounts payable to such other party should not be disclosed under accounts payable relating to player transfers, but should instead be disclosed in 'other accounts payable'.

Accounts payable to employees

- Amounts payable to employees in respect of employee benefit expenses.

Accounts payable to social/tax authorities

- Accounts payable to social/tax authorities are the taxes payable in future periods in respect of current tax liabilities.

Other tax liabilities

- Other tax liabilities, including deferred tax liabilities.

Accruals and deferred income

- These include accruals and deferred income.

Other accounts payable

- These include trade and other payables (excluding accruals and deferred income, which are separately disclosed).

Provisions

- Provisions are a subset of liabilities, being a liability of uncertain timing or amount, e.g. legal claim.
- Provisions will be classified as current or non-current based on the liability at the balance sheet date for the following periods not later than one year and later than one year.

3. Equity

Share/Fund capital

- This includes share capital, share premium and treasury shares. Treasury shares are an entity's own equity instruments, held by the entity or other members of the consolidated group. The entity cannot recognise a gain or loss in profit or loss on the purchase, sale, issue or cancellation of treasury shares.

Retained earnings

- Retained earnings are the accumulated profit or loss as at the financial year end.

Other reserves

- This includes other reserves, including revaluation reserves and any other form of reserve other than retained earnings, and minority interest.

4. Reconciliation checks

Within the balance sheet schedules of the FS and BE packages, there are reconciliations for total equity, player registrations, and tangible fixed assets. In the BE.09 package there is also the “player identification table” to be completed by some licensees (on request).

	T-1-LC	FS reclass. (LC) T-1
Total equity reconciliation check		
Total equity - brought forward at beginning of period		
Prior period adjustment / change of reporting perimeter (from previous reporting period)		
Profit/(Loss) after dividends		
Capital increase/equity contributions		
Change in revaluation reserve		
Other movements in equity/reserves during the period		
Total equity - carried forward at end of period		
Reminder of closing net book value of Total equity in the Balance Sheet		
Check		
If reporting entity applies capitalisation & amortisation method for player registration		
Cost of player registrations		
Aggregate cost at start of period		
Prior period adjustment / change of reporting perimeter (from previous reporting period)		
Cost of additions in the period		
Historical cost of player registrations disposed in the period		
Aggregate cost at end of period		
Amortisation of player registrations		
Aggregate amortisation at start of period		
Prior period adjustment / change of reporting perimeter (from previous reporting period)		
Amortisation of intangible fixed assets (player registrations)		
Accumulated amortisation of player registrations disposed in the period		
Impairment of intangible fixed assets (player registrations)		
Aggregate amortisation at end of period		
Net book value of player registrations		
NBV at Start of Period		
NBV at End of Period		
Reminder of closing net book value of Intangible assets (Players) in the Balance Sheet		
Check		
Cost of tangible fixed assets		
Aggregate cost at start of period		
Prior period adjustment / change of reporting perimeter (from previous reporting period)		
Cost of additions in the period		
Historical cost of tangible fixed assets disposed in the period		
Aggregate cost at end of period		
Depreciation of tangible fixed assets		
Aggregate depreciation at start of period		
Prior period adjustment / change of reporting perimeter (from previous reporting period)		
Depreciation of tangible fixed assets		
Depreciation of tangible fixed assets disposed in the period		
Impairment of tangible fixed assets during the period		
Aggregate amortisation at end of period		
Net book value of tangible fixed assets		
NBV at Start of Period		
NBV at End of Period		
Reminder of closing net book value of Tangible fixed assets in the Balance Sheet		
Check		

Reconciliation of total equity

- The licensee must ensure that brought-forward total equity, together with the profit or loss after dividends as recorded in the profit and loss account schedule and other movements in equity/reserves in the reporting period (as included in the equity reconciliation), correctly reconciles to total equity in the balance sheet schedule. Only if applicable, the licensee may also use the line “Prior period adjustment/change of reporting perimeter (from previous period)”, which is defined below.

- If there are no other movements in equity/reserves, and no items of recognised income or expense other than the profit (or loss) for the reporting period, the brought-forward total equity balance plus (or minus) the net profit (or loss) for the reporting period should equate to the total equity balance at the end of the reporting period.

The calculated net assets/liabilities at the end of the reporting period in the balance sheet must match the net assets/liabilities as recorded in the balance sheet of the appropriate annual financial statements.

Reconciliation of player registrations

Those licence applicants and licensees that use the capitalisation and amortisation method of accounting for player registrations must complete the player registration reconciliation, which reconciles the movements during the reporting period of the cost, amortisation and net book value of player registrations.

This requires the following disclosures, as applicable:

- total historical cost and accumulated amortisation at the start of the period, which will automatically calculate the net book value at the start of the period;
- any prior period adjustment/change of reporting perimeter compared to prior period;
- cost of player registration additions during the period;
- historical cost and accumulated amortisation of any player registrations disposed of during the period;
- amortisation charge for the period, as entered in the profit and loss account schedule; and
- any impairment charge against player registrations during the period.

Reconciliation of tangible fixed assets

Those licence applicants and licensees that recognise tangible fixed assets must complete the tangible fixed asset reconciliation, which reconciles the movements during the reporting period of the cost, depreciation and net book value of tangible fixed assets.

This requires the following disclosures, as applicable:

- total historical cost and accumulated depreciation at the start of the period, which will automatically calculate the net book value at the start of the period;
- any prior period adjustment/change of reporting perimeter compared to prior period;
- cost of tangible fixed asset additions during the period;
- historical cost and accumulated depreciation of any tangible fixed assets disposed of during the period;
- depreciation charge for the period, as entered in the profit and loss account schedule; and
- any impairment charge against tangible fixed assets during the period.

Note: For the purpose of the break-even calculation, if the depreciation/impairment charge of tangible fixed assets for the period includes amounts in respect of right-of-use assets (operating leases), then any such amount must be disclosed as part of the “Costs of right-of-use assets (operating leases)” and thereby included in the calculation of the break-even result.

Prior period adjustment/change of reporting perimeter (from previous reporting period)

Prior period adjustments for the correction of errors may either arise in the annual financial statements of a reporting entity or may be due to a previous input error in the CL/FFP IT Solution. A restatement of prior period figures in annual financial statements may also arise if there is a change of accounting policy.

The reasons for the restatement and/or prior period error and the impact on the break-even result for each reporting period and in aggregate for a monitoring period will be considered. If deemed necessary, the licensee may be requested to resubmit the break-even information for the prior period using the updated reporting perimeter, rather than just entering the aggregate impact in the total equity reconciliation.

Player identification table

As set out in Annex VI.F, all licence applicants must prepare and submit to their licensor a player identification table, which must reconcile to the relevant figures in the balance sheet and profit and loss account in the audited financial statements.

Some licensees will be required to disclose supplementary player-by-player information in the “player identification table” in the BE.09 package, for which the aggregated figures must reconcile to the relevant figures in the balance sheet and profit and loss account in the audited financial statements. This requires the following disclosures in respect of each relevant player registration:

Player identification:

- Name of the player;
- Start date of contract (DD/MM/YYYY) – date on which the player’s registration has been transferred-in permanently and the original employment contract commenced. For international transfers, this date should be the same as that required to be entered into FIFA’s Transfer Matching System;
- Duration of contract (Years) – being the aggregate number of years of the employment contract(s) from the original start date of the contract (as above), to the contracted end of current employment contract (rounded to nearest month).

Costs of acquiring a player’s registration:

- Aggregate cost at start of period – the total accumulated costs in respect of acquiring/holding the player’s registration at the start of the reporting period;
- Transfer fee in the period – transfer fee costs of acquiring a player’s registration incurred during the reporting period, being amounts paid and/or payable for agreed transfer compensation, conditional transfer compensation, and solidarity/training compensation. This excludes any internal development or other costs;
- Other capitalised costs in the period – other costs of acquiring a player’s registration incurred during the reporting period, being amounts paid and/or payable for agents/intermediaries fees and other direct costs of acquiring the player’s registration (e.g. transfer fee levy);
- Historical cost of player registrations disposed in the period – deduction for the accumulated costs of a player’s registration at the time of the transfer-out of the player’s registration;
- Aggregate cost at end of period – being the sum of aggregate cost at start of the reporting period and the transactions during the reporting period.

Amortisation and impairment of costs of acquiring a player’s registration:

- Aggregate amortisation at start of period - the total accumulated amortisation/impairment in respect of the costs of acquiring/holding the player’s registration at the start of the reporting period
- Amortisation of intangible assets (player registrations) in the period – amortisation charge to the profit and loss account incurred during the reporting period;
- Accumulated amortisation of player registrations disposed in the period - deduction for the accumulated amortisation/impairment of a player’s registration at the time of the transfer-out of the player’s registration;
- Impairment of intangible assets (player registrations) in the period – impairment charge to the profit and loss account incurred during the reporting period;
- Aggregate amortisation at end of period - being the sum of aggregate amortisation/impairment at start of the reporting period and the charges/transactions during the reporting period.

Net book value:

- NBV at start of period – being the calculated net book value in respect of the player’s registration at the start of the reporting period;
- NBV at end of period - being the calculated net book value in respect of the player’s registration at the end of the reporting period.

Other information:

- Sell-on rights (or similar) – being the description and (if possible) quantification of any sell-on rights to a football club that formerly held the player’s registration, excluding training compensation and/or solidarity contributions.

5. FS reclassification

The FS reclassification schedule shows where UEFA administration has re-classified amounts between account lines for benchmarking purposes only. There is no impact on the break-even result and, as the licensee is not required to enter any data, it is a read-only schedule.

B. Profit and loss account – Annex VI C and Annex X A to D

The licensee must prepare and submit profit and loss account information for each relevant reporting period as set out in the prescribed formats in the BE package in the CL/FFP IT Solution, based on the audited financial statements, supplementary information (for club licensing) and underlying accounting records for the licensee's reporting perimeter.

Figures must be input into the profit and loss account schedule as follows:

- in the licensee's presentation currency;
- rounded to the nearest thousand (e.g. €1,234,567 should be entered as €1,235);
- **all income items must be input as positive figures and all expense items as negative figures.**

The profit and loss account lines are listed below. The account lines highlighted in **blue** represent the minimum level of disclosure in the profit and loss account schedule.

- The account lines highlighted in green **■** are used to determine relevant income (net of adjustments).
- The account lines highlighted in red **■** are used to determine relevant expenses (net of adjustments).
- The account lines highlighted in yellow **■** will be automatically adjusted in the CL/FFP IT Solution, to be excluded from the calculation of the break-even result.

Some licensees must also provide certain additional information in their BE package, by both

- completing some of the relevant supplementary schedule(s) if applicable (**as highlighted** in the table below); and
- ensuring that the disclosures in the supplementary schedule(s) are also recorded in the profit and loss account schedule. The licensee must ensure that the supplementary schedule is fully and properly completed and that revenues/expenses are analysed/disclosed as far as possible in the account lines other than 'other'. The amount in the 'other' account line must be no greater than the displayed percentage of the relevant total.

The requirement to complete one or more profit and loss account supplementary schedules is determined on the basis of the data entered in the profit and loss account schedule and is automatically notified to the licensee in the BE package (by **X**), or as otherwise notified by the UEFA administration.

The disclosure requirements in respect of each account line are defined in Annex VI and further explained in this FFP Toolkit, together with the requirements for supplementary schedules.

Profit and Loss Account				complete supplementary schedule
P1030	Gate receipts - season tickets			
P1040	Gate receipts - membership fees			
P1051	Gate receipts - premium tickets/match day hospitality			
P1000	Gate receipts - national competitions			
P1010	Gate receipts - UEFA club competitions			
P1050	Gate Receipts- other/non-split			
	Total Gate Receipts			
P1100	Sponsorship and advertising - manufacturer sponsor			
P1110	Sponsorship and advertising - main sponsor			
P1120	Sponsorship and advertising - stadium sponsor			
P1130	Sponsorship and advertising - pitch-perimeter and board advertising			
P1140	Sponsorship and advertising - other/non-split			
	Total Sponsorship & Advertising			
P1200	Broadcasting rights - national competitions			
P1220	Broadcasting rights - other/non-split			
	Total Broadcasting Rights			
P1300	Commercial - national competitions			
P1330	Commercial - merchandising			
P1340	Commercial - non-matchday usage of facilities			
P1350	Commercial from Membership (non matchday related)			
P1370	Commercial - other/non-split			
	Total Commercial			
P1400	UEFA club competitions - broadcasting rights, commercial, prize money			
P1410	UEFA club competitions - solidarity payments			
P1420	UEFA solidarity and prize money - other/non-split			
	Total UEFA Solidarity and Prize Money			
P1500	Subsidies, donations or other amounts from national football bodies			
P1510	Subsidies, grants or other money from the government of the territory of the licensee			
P1530	Donations from non related parties			
P1540	Contributions/donations from related parties			
P1560	Income from non-football operations			
P1575	Exceptional Income			
P1580	Other operating income - other/non-split			
	Total Other Operating Income			
	Total Revenue			

P1910	Cost of sales/materials - other/non-split			
	Total Cost of Sales/Materials			
P2000	Players - wages and salaries			
P2020	Players - social security contributions			
P2030	Players benefits expenses - other/non-split			
	Total Players Benefits Expenses			
P2100	Other employees - wages and salaries			
P2120	Other employees - social security contributions			
P2130	Other employees benefits expenses - other/non-split			
	Total Other Employee Benefits Expenses			
P2200	Employee benefits expenses - other/non-split			
	Total Employee Benefits Expenses			
P2300	Depreciation of tangible fixed assets			
P2320	Amortisation/Impairment of other intangible assets (excluding player registrations)			
P2330	Impairment of tangible fixed assets			
	Total Depreciation, Amortisation & Impairment (excluding player registrations)			
P2310	Cost of right-of-use assets (operating leases)			
P2545	Matchday expenses			
P2550	Sponsorship and advertising expenses			
P2555	Commercial activities expenses			
P2560	Property & facilities expenses			
P2570	Expenses of non-football operations			
P2585	Exceptional expenses			
P2590	Other operating expenses - other/non-split			
	Total Other Operating Expenses			
	Total Operating Expenses (excluding player registration)			
	Player trading			
P2600	Amortisation of intangible fixed assets (player registrations)			
P2605	Impairment of intangible fixed assets (player registrations)			
P2610	Profit on disposal of intangible fixed assets (player registrations)			
P2620	Loss on disposal of intangible fixed assets (player registrations)			
P2700	Cost of acquiring player registrations (including non capitalised agent and loan fees)			
P2710	Income from disposal of player registrations (including loan income)			
	Total player trading			
P3030	Profit/(loss) on disposal of tangible fixed assets			
P3040	Profit/(loss) on disposal of other intangible fixed assets			
	Total Profit/(Loss) on Disposal of Fixed Assets			
P4000	Finance income			
P4010	Finance expense			
P4015	Net Foreign Exchange Gains/(Losses)			
	Net Finance Income/(Expense)			
P5000	Other income (non operating)			
P5100	Other expenses (non operating)			
	Net Non-operating Income/(Expense)			
P6000	Tax income/(expense)			
	Profit / (Loss) after Tax			

1. Revenue – gate receipts – Annex X B (a)

Gate receipts are revenue derived from spectators attending the club's football matches from whatever type of arrangement exists for a person to gain entry to the stadium, e.g. general admission season ticket, single matchday tickets, or a premium/corporate ticket package. If a club provides tickets to some spectators free of charge (or for a nominal charge), there should be no upwards adjustment to revenue. Gate receipts should be recorded net of discounts, levies, VAT and other sales-related taxes.

For the purpose of the break-even information, gate receipts may be analysed by the following account lines:

- season ticket revenue; for the purposes of this analysis, gate receipts revenue derived from season tickets (for both general admission and premium/corporate tickets) may either be included in this account line or appropriately apportioned to matches in national competitions and UEFA club competitions;
- membership fees, being some form of arrangement whereby the club provides some type of benefit(s) for paying members in respect of their match attendance and involvement with the football club;
- gate receipts relating to premium ticket/match day with hospitality access provided;
- gate receipts relating to matches in national competitions;
- gate receipts relating to matches in UEFA club competitions; and
- other gate receipts, such as those relating to friendly matches.

If a licensee does not provide a gate receipts analysis as set out above, it must input the total gate receipts figure into the "gate receipts – other/non-split" account line.

Other revenue streams generated on a matchday (e.g. sales of food and beverages, and match programmes) should be separately included in the relevant account lines as described below.

Supplementary schedule

As notified in the BE package, licensees may be required to provide additional information in their BE package for "revenue – gate receipts", by both completing the relevant supplementary schedule (extract below) and ensuring that the necessary disclosures are also recorded in the profit and loss account schedule.

Revenue - Gate receipts	Reporting period T-1		
	Revenue in reporting period - unadjusted (LC)	Explanatory comments	Number of matches
General admission			
Premium tickets with hospitality access/provided			
corporate/premium attendees - boxes/bulk			
Other			
Gate receipts - Season tickets			
League - home matches			
League - share from away matches			
National cup 1 - home matches			
National cup 1 - share from away matches			
National cup 2 - home matches			
National cup 2 - share from away matches			
Other			
Gate Receipts - National Competitions			
UEL matches - home matches			
UCL matches - home matches			
Reallocation share of season tickets relating to UEFA club competition matches			
Other			
UEFA Club Competitions			
General admission			
Corporate/premium attendees - individuals			
Corporate/premium attendees - boxes/bulk			
Other			
Gate Receipts - Season Tickets			
Gate Receipts - Membership Fees			
Gates Receipts - Premium tickets match day hospitality			
Gate Receipts - Other			
Total Gate Receipts			

When requested, a licensee must complete the supplementary schedule to provide more detailed analysis and explanations covering:

- gate receipts relating to matches in national competitions – revenue analysed by the different types of matches and the number of matches played;
- gate receipts relating to matches in UEFA club competitions – revenue analysed by competition and the number of home matches played;
- season ticket revenue – revenue analysed by types of season ticket packages;
- membership fees; and
- other gate receipts.

Explanatory comments should be provided by the licensee, covering matters such as number of tickets sold, match attendance data, significant variations compared to other reporting periods, inclusion of any unusual transactions and, if known and applicable, why there may be significant variations to other licensees playing in the same national competitions.

2. Revenue – sponsorship and advertising – Annex X B (b)

Sponsorship and advertising revenue is derived from arrangements by which the club receives monies from a party in exchange for some form of rights provided to the other party in order to be associated in some way with the club and/or advertise through a variety of channels associated with the club (e.g. pitch-perimeter and other board advertising, or match programme advertising).

For the purpose of the break-even information, sponsorship and advertising may be analysed by the following account lines:

- **Manufacturer sponsor**, being the amount of sponsorship and advertising revenue (if any) derived from the arrangement with the party that provides the first team’s kit and other apparel, excluding any amount from such party that relates to merchandising sales (which should be included in commercial/merchandising).
- **Main sponsor**, being the amount of sponsorship and advertising revenue derived from the arrangement with the party which is the primary sponsor (typically the sponsor on the front of the first team’s shirts). The disclosure should include all amounts derived from the arrangement with the sponsor, which will typically include sponsorship rights in addition to the front of the first team’s shirts. This account line should only include revenue from the main sponsor; any revenue derived from other sponsors which may also appear on a team’s shirts/apparel must be included in the account line sponsorship and advertising – other.
- **Stadium sponsor**, being the amount of sponsorship and advertising revenue (if any) derived from the arrangements with the party that has the stadium naming rights. The disclosure should include all amounts derived from the arrangements with the sponsor, which may include sponsorship rights in addition to stadium naming rights. This account line should only include revenue from the stadium naming rights sponsor; any revenue derived from other sponsors in respect of the stadium (e.g. for naming rights for a particular stand within the stadium) must be included in the account line “sponsorship and advertising – other”.
- **Pitch perimeter and board advertising**, being sponsorship and advertising revenue derived from arrangements for other parties to have some form of advertisement at the stadium; if arrangements with the three types of sponsors set out above include pitch-perimeter and board advertising, there should be no apportionment from manufacturer or kit or stadium sponsor to this account line.
- **Other sponsorship and advertising**, being any other amounts not otherwise categorised.

If a licensee does not provide an analysis of sponsorship and advertising revenue as set out above, it must input the total sponsorship and advertising figure into the account line “sponsorship and advertising – other/non-split”.

Supplementary schedule

As notified in the BE package, licensees may be required to provide additional information in their BE package for “revenue – sponsorship and advertising”, by both completing the relevant supplementary schedule (extract below) and ensuring that the necessary disclosures are also recorded in the profit and loss account schedule.

Revenue - Sponsorship and advertising	Reporting period T-1								
	Revenue in reporting period - unadjusted (LC)	Sponsor name	Related party (yes/no)	Contract start date			Summary of rights/benefits	Revenue recognised that was not contingent	Revenue recognised that was contingent
				DD	MM	YY			
Manufacturer sponsor									
Sponsorship and Advertising - Manufacturer Sponsor									
Main sponsor									
Sponsorship and Advertising - Main sponsor									
Stadium sponsor (>20% of total)									
Sponsorship and Advertising - Stadium sponsor									
Pitch-perimeter and board advertising (>20% of total)									
Other arrangements									
Sponsorship and Advertising - Pitch-perimeter and board advertising									
Other arrangements									
Sponsorship and Advertising - Other									
Total Sponsorship & Advertising									

When requested, a licensee must complete the supplementary schedule to provide more detailed analysis and explanations.

For each of the manufacturer sponsor, the main sponsor, the stadium sponsor, pitch-perimeter and board advertising (for arrangements contributing more than 20% of the total sponsorship and advertising revenue), and other sponsorship arrangements (for arrangements contributing more than 20% of the total sponsorship and advertising revenue), the licensee must disclose:

- the name of the sponsor;
- whether the sponsor is a related party, by entering ‘yes’ or ‘no’;
- the contract start date;
- explanatory comments summarising the rights and benefits provided to the other party;
- the amount of revenue recognised during the reporting period that was not contingent, i.e. was guaranteed to be received regardless of other factors; and
- the amount of revenue recognised during the reporting period that was contingent, i.e. was received as a result of a certain outcome, such as the licensee’s league finishing position or progression in UEFA club competitions.

3. Revenue – broadcasting rights – Annex X B (c)

Broadcasting rights revenue is derived from arrangements by which the club receives monies in respect of the sale of broadcasting rights for matches and any football club generated material for broadcast, through whatever broadcast medium (e.g. television, radio, internet, and mobile phones). Broadcasting rights revenue may be received either directly from a broadcaster or indirectly from a competition organiser.

For the purpose of the break-even information, broadcasting rights revenue may be analysed by the following account lines:

- broadcasting rights revenue relating to a club’s participation in matches in national competitions; and
- broadcasting rights revenue for a club’s participation in other types of matches and/or other types of football club generated content for broadcast. Note that monies received from a club’s participation in UEFA club competitions in a season must be separately included in “revenue – UEFA solidarity & prize money”.

If a licensee is in receipt of monies from a competition organiser that is generated from the sale of both broadcast rights and other commercial rights and if the amount derived from the sale of other commercial rights is separately identifiable, then it must be included in commercial activities. If the amount derived from the sale of other

commercial rights is not separately identifiable, the full amount from a competition organiser must be disclosed under broadcasting rights.

If a licensee does not provide an analysis of broadcasting rights revenue as set out above, it must input the total broadcasting rights figure into the account line “broadcasting rights – other/non-split”.

Supplementary schedule

As notified in the BE package, licensees may be required to provide additional information in their BE package for “revenue – broadcasting rights”, by both completing the relevant supplementary schedule (extract below) and ensuring that the necessary disclosures are also recorded in the profit and loss account schedule.

	Reporting period T-1	
	Revenue in reporting period - unadjusted (LC)	Explanatory comments
League		
National cup 1		
National cup 2 (if applicable)		
Other		
Broadcasting Rights - National competitions		
Arrangement 1 (>20% of total)		
Other arrangements		
Broadcasting Rights - Other		
Total Broadcasting Rights		

When requested, a licensee must complete the supplementary schedule to provide more detailed analysis and explanations covering:

- broadcast rights revenue relating to a club’s participation in matches in national competitions – revenue analysed by the different types of matches; and
- other broadcast rights revenue, disclosing separately any broadcast arrangements contributing more than 20% of the total broadcast rights revenue.

Explanatory comments should be provided by the licensee, covering matters such as significant variations compared to other reporting periods, inclusion of any unusual transactions and, if known and applicable, why there may be significant variations to other licensees playing in the same national competitions.

4. Revenue – commercial activities – Annex X B (d)

Revenue from commercial activities is derived from commercial activities other than sponsorship and advertising and the sale of broadcasting rights. Such commercial revenue may be derived from activities relating to a specific match (e.g. food and beverage sales from both general admission matchday spectators and premium/corporate matchday packages, and sales of match programmes), or from other commercial activities.

For the purpose of the break-even information, revenue from commercial activities may be analysed by the following account lines:

- commercial revenue relating to matches in national competitions;
- merchandising, being revenue derived from sales of goods, such as replica club shirts and other club-branded apparel/goods;
- non-matchday use of a club’s facilities (e.g. conferencing at the stadium and music events);
- membership (non-matchday related), being some form of arrangement whereby the club provides some type of benefit(s) for paying members in respect of matters other than attending matches; and
- any other commercial activities revenue not otherwise categorised above (e.g. lottery, licence fees and royalties for use of the club’s brand, and commission).

If a licensee does not provide an analysis of commercial revenue as set out above, then it must input the total commercial revenue figure into the account line “commercial – other/non-split”.

Supplementary schedule

As notified in the BE package, licensees may be required to provide additional information in their BE package for “revenue – commercial activities”, by both completing the relevant supplementary schedule (extract below) and ensuring that the necessary disclosures are also recorded in the profit and loss account schedule.

	Reporting period T-1	
	Revenue in reporting period - unadjusted (LC)	Explanatory comments
League - home matches		
National cup 1 - home matches		
National cup 2 (if applicable) - home matches		
Other		
Commercial - National competitions		
Main merchandising arrangement (>20% of total)		
Other arrangements		
Commercial - Merchandising		
Major events		
Other events / usage		
Commercial - Non-matchday usage of facilities		
From Membership (>20% of total)		
Other arrangements		
Commercial from Membership (non matchday related)		
Other commercial income (>20% of total)		
Other arrangements		
Other		
Total Commercial		

When requested, a licensee must complete the supplementary schedule to provide more detailed analysis and explanations covering:

- commercial revenue relating to a club’s participation in matches in national competitions – revenue analysed by the different types of matches;
- merchandising revenue, with any arrangements contributing more than 20% of total commercial revenue to be separately disclosed;
- the revenue generated from non-match day usage of facilities, with revenue from major events such as hosting pop concerts to be separately disclosed from other events;
- membership (non-matchday related), being some form of arrangement whereby the club provides some type of benefit(s) for paying members in respect of matters other than attending matches; and
- other commercial revenue, disclosing separately any commercial arrangements contributing more than 20% of total commercial revenue.

Explanatory comments should be provided by the licensee, covering matters such as significant variations compared to other reporting periods, inclusion of any unusual transactions and, if known and applicable, why there may be significant variations to other licensees playing in the same national competitions. Where applicable, explanatory comments should also include details of the major events held at the licensee’s facilities and the name and terms of the merchandising and other commercial revenue which have been disclosed separately as they contribute more than 20% of the total.

5. Revenue – UEFA solidarity & prize money – Annex X B (e)

UEFA solidarity and prize money is revenue for a licensee derived from UEFA’s solidarity distributions for the benefit of clubs, and/or revenue for a licensee from UEFA for fulfilment of a club’s obligations regarding participation in a UEFA club competition in a season (excluding match gate receipts, which must be included under “gate receipts”).

Guidance for those licensees making an adjustment for financial contributions in relation to settlement agreements is provided in **Appendix V (M)**.

6. Revenue – other operating income – Annex X B (f)

For the purpose of the break-even information, other operating income may be analysed by the following account lines:

- subsidies, donations or other amounts from national football bodies; this account line excludes any amounts from national football bodies for broadcasting rights and/or commercial activities for national competitions, and excludes any amount separately identifiable as UEFA solidarity payments, each of which must be categorised accordingly;
- subsidies, grants or other money from the government of the territory of the relevant licensee;
- donations received from non-related parties (other than national football bodies and/or government);
- contributions/donations received from related parties;
- income from non-football operations (not otherwise included in another revenue account line);
- exceptional income (not otherwise included in another revenue account line); and
- any other operating income not otherwise categorised above, such as rental income and dividends.

Further guidance about non-football operations is given in **Appendix V (D)**. If the profit and loss account includes amounts in respect of non-football operations not related to the club, adjustments must be made to exclude such amounts from the calculation of the break-even result.

If a licensee does not provide an analysis of other operating income as set out above, it must input the total of other operating income into the account line “other operating income – other/non-split”.

Supplementary schedule

As notified in the BE package, licensees may be required to provide additional information in their BE package for “revenue – other operating income”, by both completing the relevant supplementary schedule (extract below) and ensuring that the necessary disclosures are also recorded in the profit and loss account schedule.

Revenue - Other operating income	Reporting period T-1	
	Revenue in reporting period - unadjusted (LC)	Explanatory comments
From National Association		
From other football body		
Subsidies, donations or other amounts from national football bodies		
Authority 1 (>20% of total)		
Other government authorities		
Subsidies, grants and other money from the government of the territory of the licensee		
Donor 1 (>20% of total)		
Other donors		
Donations from non related parties		
Contributions/donations from related parties		
Income from non-football operations		
Exceptional income		
Other operating income - other		
Total Other Operating Income		

When requested, a licensee must complete the supplementary schedule to provide more detailed analysis and explanations covering:

- subsidies, donations or other amounts received from national football bodies;
- subsidies, grants or other amounts received from government in the territory of the relevant licensee, with any amounts contributing more than 20% of total other operating income to be disclosed separately;
- donations from non-related parties, with any donations contributing more than 20% of total operating income to be disclosed separately;

- contributions/donations from related parties (including subsidies, grants or other amounts received from government if they are related to licensee);
- income from non-football operations;
- exceptional income; and
- other operating income – other (providing a further breakdown of significant types of other operating income).

Explanatory comments should be provided by the licensee, covering matters such as significant variations compared to other reporting periods, any unusual transactions, sources of income, and any potential repayable amounts.

7. Expenses – cost of sales/materials – Annex X C (a)

For the purpose of the break-even information, licensees must provide the total cost of sales/materials for all activities such as catering, merchandise, medical care, kits and sports materials.

Supplementary schedule

As notified in the BE package, licensees may be required to provide additional information in their BE package for “expenses – cost of sales/materials”, by both completing the relevant supplementary schedule (extract below) and ensuring that the necessary disclosures are also recorded in the profit and loss account schedule.

Cost of sales/materials	Reporting period T-1	
	Expenses in reporting period - unadjusted (LC)	Explanatory comments
Merchandising arrangement 1 (>20% of total)		
Other merchandising arrangements		
Catering sales		
Medical care		
Kits and sports materials		
Other activities		
Total Cost of Sales / Materials		

When requested, a licensee must complete the supplementary schedule to provide more detailed analysis and explanations covering:

- expenses related to merchandising arrangements, including separate disclosure of expenses contributing more than 20% of total cost of sales/materials;
- catering sales;
- medical care;
- kits and sports materials; and
- other activities.

Explanatory comments should be provided by the licensee, covering matters such as significant variations compared to other reporting periods, inclusion of any unusual transactions and, if known and applicable, why there may be significant variations to other licensees playing in the same national competitions.

8. Expenses – employee benefit expenses – Annex X C (b)

For the purpose of the break-even information, employee benefit expenses may be analysed by type of employees, separately disclosing amounts in respect of “players and “other employees”, and may be further analysed by the nature of the employee benefit expenses (separately disclosing wages and salaries, social security contributions and other employee benefit expenses).

For the purpose of this analysis, “players” refers to all football players registered during the reporting period, including youth football players. “Other employees” refers to all employees other than football players of the reporting entity, including, but not limited to, coaching staff, medical staff, administrative staff, matchday staff, members of the executive body and the employees of non-football operations.

Wages and salaries include, but are not limited to, wages, salaries, fees, signing-on fees, bonuses, image rights payments and other incentive payments. Social security contributions are any contributions by the entity to any government, fund or arrangement. “Other” refers to any other non-monetary benefits, post-employment benefits, other long-term employee benefits, termination benefits and share-based payment transactions.

If a licensee does not provide an analysis of employee benefit expenses as set out above, it must input the total employee benefit expenses into the account line “employee benefit expenses – other/non-split” (P2200).

Supplementary schedule

As notified in the BE package, licensees may be required to provide additional information in their BE package for “expenses – employee benefit expenses”, by both completing the relevant supplementary schedule (extract below) and ensuring that the necessary disclosures are also recorded in the profit and loss account schedule.

Employee benefits expenses	Reporting period T-1			
	Expenses in reporting period - unadjusted (LC)	Explanatory comments	Number of employees	Amount per employee (LC)
Players (excluding youth players)				
Wages and Salaries				
Bonuses/incentive payments				
Image rights				
Other wages and salaries				
Total wages and salaries				
Social Security Contributions				
Other (<10% of Total)				
Players (excluding youth players) - total				
Youth players				
Total wages and salaries				
Social security contributions				
Other				
Youth players - total				
Total Player Benefits Expenses				
Coaching staff				
Coaching staff - Wages and Salaries				
Coaching staff - Social Security Contributions				
Coaching staff Benefits Expenses - Other				
Coaching staff - total				
Other employees				
Other Employees - Wages and Salaries				
Other Employees - Social Security Contributions				
Other Employees Benefits Expenses - Other				
Other employees - total				
Employee benefits expenses - other				
Total Employee Benefit Expenses				

A licensee must complete the supplementary schedule to provide more detailed analysis and explanations covering:

- players (excluding youth players) – employee benefits expenses analysed by wages and salaries (basic), image rights payments, bonuses/incentive payments, social security contributions, other employee benefits expenses, and the number of employees;
- youth players – employee benefits expenses analysed by total wages and salaries, social security contributions, other employee benefits expenses, and the number of employees;

- coaching staff – employee benefits expenses analysed by total wages and salaries, social security contributions, other employee benefits expenses, and the number of employees; and
- other employees (being all employees other than players, youth players and coaching staff) – employee benefits expenses analysed by total wages and salaries, social security contributions, other employee benefits expenses, and number of employees;

Explanatory comments should be provided by the licensee, covering matters such as significant variations compared to other reporting periods, inclusion of any unusual transactions and, if known and applicable, why there may be significant variations to other licensees playing in the same national competitions.

9. Expenses – depreciation/impairment of tangible fixed assets – Annex X D (a)

Depreciation is the systematic allocation of the depreciable amount of an asset over its useful life, i.e. the period over which an asset is expected to be available for use by an entity. An impairment loss is the amount by which the carrying amount of a tangible asset exceeds its recoverable amount, i.e. the higher of an asset's fair value less costs to sell and value in use.

The licensee must enter the appropriate figure for the depreciation of tangible fixed assets. For the break-even calculation, the annual charge for depreciation of certain tangible fixed assets is excluded from relevant expenses; this adjustment will be visible in the CL/FFP IT Solution.

If the licensee has any depreciation/impairment costs in respect of right-of-use assets that are operating leases, then any such costs must be separately disclosed as part of "Other operating expenses" and will be included in relevant expenses for the break-even calculation.

The licensee must enter the figure for impairment of tangible fixed assets, aggregated with the figure for impairment of other intangible assets (excluding player registrations), in the account line Impairment of tangible fixed assets and/or other intangible assets. For the break-even calculation, any charge for impairment of tangible fixed assets (and/or other intangible assets) is excluded from relevant expenses; this adjustment will be visible in the CL/FFP IT Solution.

10. Expenses – amortisation/impairment of intangible assets (excluding player registrations) – Annex X D (b)

Amortisation is the systematic allocation of the depreciable amount of an asset over its useful life, i.e. the period over which an asset is expected to be available for use by an entity. An impairment loss is the amount by which the carrying amount of an asset exceeds its fair value less costs to sell.

The licensee must enter the appropriate figure for the amortisation of intangible assets (excluding player registrations). For the break-even calculation, in general the annual amortisation of intangible assets (other than player registrations) is excluded from relevant expenses only if the intangible asset did/does not generate relevant income; this adjustment will be visible in the CL/FFP IT Solution.

The licensee must enter the figure for impairment of other intangible assets (excluding player registrations), aggregated with the figure for impairment of tangible fixed assets, in the account line Impairment of tangible fixed assets and/or other intangible assets. For the break-even calculation, any charge for impairment of other intangible assets (and/or tangible fixed assets) is excluded from relevant expenses only if the intangible asset did/does not generate relevant income; this adjustment will be visible in the CL/FFP IT Solution.

The amortisation/impairment of any finance costs (reflected as intangible assets) has to be included in the break-even calculation.

11. Expenses – other operating expenses – Annex X C (c)

For the purpose of the break-even information, other operating expenses may be analysed by the following account lines:

- matchday expenses, being expenses in respect of hosting of matches at the home stadium such as policing and stewarding;
- sponsorship and advertising expenses, being expenses in respect of the activities undertaken to generate sponsorship and advertising revenue;

- commercial activities expenses, being expenses in respect of the activities undertaken to generate commercial revenue;
- depreciation/impairment costs of right-of-use assets that are operating leases;
- property and facilities expenses, being expenses incurred in respect of the day-to-day use of the stadium, training facilities and other properties used by the entity, including the day-to-day servicing of the property, repairs and maintenance, and costs of conducting business in a property (e.g. rental payments, property-related payments to government); for the avoidance of doubt, this account line must not include depreciation/impairment of tangible fixed assets;
- expenses of non-football operations (not otherwise included in another expense account line);
- exceptional expenses (not otherwise included in another expense account line); and
- any other operating expenses not otherwise categorised above.

Further guidance about non-football operations is given in **Appendix V (D)**.

For the avoidance of doubt, “other operating expenses” must not include any amounts of employee benefit expenses.

If a licensee does not provide an analysis of other operating expenses as set out above, it must input the total other operating expenses into the account line “other operating expenses – other/non-split”.

Supplementary schedule

As notified in the BE package, licensees may be required to provide additional information in their BE package for “expenses – other operating expenses”, by both completing the relevant supplementary schedule (extract below) and ensuring that the necessary disclosures are also recorded in the profit and loss account schedule.

Other operating expenses	Reporting period T-1	
	Expenses in reporting period - unadjusted (LC)	Explanatory comments
Police and stewarding		
Other		
Matchday expenses		
Sponsorship and advertising expenses		
Commercial activities expenses		
Stadium site		
Training facilities		
Other properties		
Property and facilities expenses		
Costs of rights-of-use assets (operating leases)		
Expenses of non-football operations		
Exceptional expenses		
Other operating expenses - Other		
Total Other Operating Expenses		

Explanatory comments should be provided by the licensee, covering matters such as significant variations compared to other reporting periods, inclusion of any unusual transactions and, if known and applicable, why there may be significant variations to other licensees playing in the same national competitions.

Other operating expenses – other should be further analysed, with separate disclosure of significant types of other operating expenses.

12. Player transfers – Annex X C (d) and Annex X B (g)

Accounting for the permanent transfer of a player’s registration

For data entry into the profit and loss account schedule, the licensee must input the figures from its annual financial statements. With regard to the method of accounting for player registrations in its annual financial

statements, a licensee will apply either the capitalisation and amortisation method or the income and expense method.

For clubs which use the ‘capitalisation and amortisation’ method of accounting for player registrations in their annual financial statements, relevant income and relevant expenses must reflect this same accounting treatment.

If a licensee which uses the income and expense method of accounting for player registrations in its annual financial statements elects to apply the capitalisation and amortisation method, it must make appropriate adjustments for the calculation of the break-even result by fully completing the player accounting adjustment schedule. See **Appendix V (K)** of this document for further details. The selected treatment must be applied on a consistent basis from one reporting period to the next.

If a licensee which uses the capitalisation and amortisation method does not apply the minimum accounting requirements as described in Annex VII C, then it must make appropriate adjustments for the calculation of the break-even result by completing the player accounting adjustment schedule.

P2600– Amortisation of player registrations

For a reporting entity that uses the ‘capitalisation and amortisation’ method of accounting for player registrations in its annual financial statements, the amortisation and/or impairment of costs of acquiring player registrations in a reporting period must be calculated in accordance with the minimum accounting requirements as described in **Annex VII C**.

If the period of a player’s contract with the club falls entirely within an annual reporting period, then the direct costs of acquiring a player’s registration will be fully amortised in the reporting period and should be reported in the account line P2600 rather than P2700.

P2605 – Impairment of player registrations

For a reporting entity that uses the ‘capitalisation and amortisation’ method of accounting for player registrations, it should consider the need for recognition of an impairment loss of the net book value of the costs of a player’s registration. In general, the need to recognise an impairment loss is rare and clear evidence is required to validate the accounting treatment.

P2610 – Profit on disposal of player registrations

For a reporting entity that uses the ‘capitalisation and amortisation’ method of accounting for player registrations, profit on disposal of a player’s registration is calculated by deducting the net book value of the player’s registration at the time of the transfer from the net disposal proceeds received and receivable.

A profit on disposal of a player’s registration will be reported if the net disposal proceeds exceed the net book value of the player’s registration at the time of the transfer. Any such profit must be included within relevant income for the calculation of the break-even result.

As set out in Annex X B (m), any income/profit generated in respect of a player for whom the licensee retains the registration must be excluded from the calculation of the break-even result by making the necessary adjustment in the “player accounting adjustment” schedule.

This means that any profit arising on the disposal of economic rights or similar of a player to any other party must be deferred and a profit can only be recognised in the break-even calculation following the permanent transfer of a player’s registration to another club.

P2620 – Loss on disposal of player registrations

The loss on disposal of a player’s registration is calculated by deducting the net book value of the player’s registration at the time of the transfer from the net disposal proceeds received and receivable.

A loss on disposal of a player’s registration will be reported if the net disposal proceeds are less than the net book value of the player’s registration at the time of the transfer. Any such loss must be included within relevant expenses for the calculation of the break-even result.

P2700 – Costs of acquiring player registrations (including non-capitalised agent fees and loan fees)

For a reporting entity that uses the ‘income and expense’ method of accounting for player registrations, the costs of acquiring a player’s registration are recorded in a reporting period. These costs include the transfer compensation to another football club, fees to agents/intermediaries and other direct costs of acquiring the registration.

As per the accounting requirements set out in Annex VI.C, any loan fees incurred in a reporting period for the temporary transfer-in of a player’s registration must be included in the account line P2700.

P2710 – Income from disposal of player registrations (including loan income)

For a club that uses the ‘income and expense’ method of accounting for player registrations, income from the disposal of a player’s registration is the net disposal proceeds generated from the transfer of the player’s registration to another club.

As per the accounting requirements set out in Annex VII.D, any loan fees arising in a reporting period for the temporary transfer-out of a player’s registration must be included in the account line P2710.

Supplementary schedule

As notified in the BE package, licensees may be required to provide information in their BE package for player transfers by completing the relevant supplementary schedule (extract below).

Player transfers									
Player name	Name of club to which the player’s registration transferred	Registration transfer date			Reporting period T-1				
		DD	MM	YY	Disposal proceeds received and receivable	Net book value of the player’s registration	Any direct costs of transfer	Profit/Loss on disposal	Explanatory comments
Profit/ Loss on disposal of intangible fixed assets (player registration)									
Player 1									
Player 2									
Player 3									
Other players									
Profit/ Loss on disposal of intangible fixed assets (player registration)					[]				

Player transfers									
Player name	Name of club to which the player’s registration transferred	Registration transfer date			Reporting period T-1		Income from disposal of player registrations	Explanatory comments	
		DD	MM	YY	If transfer enter 1	If loan enter 1			
Income from disposal of player registrations (including loan income)									
Player 1									
Player 2									
Player 3									
Other players									

When requested, a licensee must complete the supplementary schedule to provide more detailed analysis and explanations covering:

- the player’s name;
- the name of the club to which the player’s registration was transferred (or the entity to which economic rights were sold);
- the date the player’s registration was transferred to the acquiring club (or the date the economic rights were sold);

For licensees using the capitalisation and amortisation method of player accounting:

- the disposal proceeds received and receivable from the acquiring club (and/or, if applicable, from other parties);
- the net book value of the player’s registration at the date the player’s registration was transferred to the acquiring club;
- any direct costs incurred by the licensee as a result of the transfer; and
- the profit or loss on disposal.

For licensees using the income and expense method of player accounting:

- whether the player has been transferred-out permanently (select “Transfer”) or temporarily on loan to another club (select “Loan”); and
- income in respect of the transfer/loan of the player’s registration.

Explanatory comments should be provided by the licensee to cover matters including the name(s) of the acquirer(s) of the player’s economic rights or similar.

Further guidance about the requirements to make an adjustment for the break-even calculation for any income/profit in respect of a player for whom the licensee retains the registration is given in **Appendix V (K)**.

13. Profit/loss on disposal of tangible fixed assets – Annex X D (a)

The profit/loss on disposal of a tangible fixed asset is the difference between the net disposal proceeds and the carrying amount of the item at the time of disposal.

For the break-even calculation, a profit or loss on the disposal of a tangible fixed asset is to be excluded from the calculation of the break-even result; this adjustment will be done automatically in the CL/FFP IT Solution.

If a licensee meets the conditions as defined in Annex X B (h) and chooses to provide supplementary information, it may include in the break-even calculation an amount for the excess proceeds on the disposal of a tangible fixed asset. See **Appendix V (H)** of this document for further guidance about this type of adjustment.

14. Profit/loss on disposal of intangible assets (excluding player registrations) – Annex X D (b)

The profit/loss on disposal of an intangible asset (excluding player registrations) is the difference between the net disposal proceeds and the carrying amount of the item at the time of disposal.

For the break-even calculation, a profit or loss on disposal of intangible assets (excluding player registrations) is to be excluded from the break-even result only if the intangible asset did not generate relevant income.

15. Finance income, finance costs and foreign exchange result – Annex X B (i) and Annex X C (e)

Annex X B (i) – Finance income must be disclosed separately in the profit and loss account schedule (rather than netted against finance costs) for the calculation of relevant income for the break-even result.

Annex X C (e) – Finance costs must be disclosed separately in the profit and loss account schedule for the calculation of relevant expenses for the break-even result.

Annex X B (i) – The net foreign exchange result for gains and losses on monetary items, whether realised or unrealised, must be entered for the calculation of the break-even result.

Supplementary schedule

As notified in the BE package, licensees may be required to provide additional information in their BE package for finance income, finance costs and/or foreign exchange result, by completing the relevant supplementary schedule (extract below).

Finance income, expenses and foreign exchange result		
	Reporting period T-1	
	Amount in reporting period - unadjusted (LC)	Explanatory comments
Finance income arrangement 1 (>20% of total)		
Other arrangements		
Finance income		
Finance expenses arrangement 1 (>20% of total)		
Other arrangements		
Finance expenses		
Net foreign exchange gains/(losses)		
Net finance income/(expenses)		

When requested, a licensee must complete the supplementary schedule to provide more detailed analysis and explanations covering finance income/costs arrangements.

Financing arrangements between the licensee and another entity (such as a bank, other financial institution, other type of entity providing finance arrangements, owner, or other related party) that contribute more than 20% of total finance income/costs must be separately disclosed.

In addition, any financing arrangements between the licensee and the owner and/or other related party, where the licensee has a liability at any time during the reporting period, must also be separately disclosed, regardless of the amount of finance expense in the reporting period.

Explanatory comments should be provided by the licensee, covering matters such as significant variations compared to other reporting periods, inclusion of any unusual transactions and, for those arrangements which contribute more than 20% of total finance income/costs and/or are with an owner/related party, the name of the lender/borrower and the terms (length and interest rate) of the arrangement.

Any material amount of foreign exchange gain or loss must be separately disclosed on account line “net foreign exchange gains/losses”.

16. Other income and expenses

Other income and other expenses not otherwise included in another line in the profit and loss account schedule must be disclosed separately.

Disclosure of amounts in other income and/or other expenses is expected to be rare because the typical income and expenses of football club activities should normally be included in one of the other account lines in the prescribed format of the profit and loss account schedule in the CL/FFP IT Solution.

Supplementary schedule

As notified in the BE package, licensees may be required to provide additional information in their BE package for other income and other expenses, by completing the relevant supplementary schedule (extract below).

	Reporting period T-1	
	Amount in reporting period - unadjusted (LC)	Explanatory comments
Element 1		
Element 2		
Other income (non operating)		
Element 1		
Element 2		
Other expenses (non operating)		

When requested, a licensee must complete the supplementary schedule to provide more detailed analysis and explanations covering any other income and any other expenses.

17. Tax income/expense – Annex X D (c)

The licensee must enter the appropriate figure for tax income/expense, being the aggregate amount included in the determination of profit or loss for the period in respect of current tax and deferred tax. Tax expense does not include value added taxes or tax and social security contributions in respect of employees.

The tax figure – whether it be a credit or a debit in the profit and loss account – is excluded for the calculation of the break-even result. This line item will be adjusted automatically in the CL/FFP IT Solution for the calculation of the break-even result.

18. Dividends paid / Minority interests – Annex X C (e)

Dividends are distributions to holders of equity instruments. If dividends are recognised in the financial statements, regardless of whether the dividends are presented in the profit and loss account or an alternative statement, the amount of dividends must be included as relevant expenses.

Minority interest is the equity in a subsidiary owned by an entity other than the parent. The amount of annual profit or loss allocated to minority interests in this subsidiary should be on the basis of the level of equity that they own.

The figure for profit/loss after dividends paid and/or payable and/or minority interests in the profit and loss account schedule is automatically included as part of a reconciliation in the balance sheet schedule.

C. Cash flow statement – Annex VI D

The cash flow statement provides information about the changes in cash and cash equivalents for the licensee's reporting perimeter for a reporting period, disclosing changes from operating activities, investing activities and financing activities.

The licensee must prepare and submit cash flow statement information for each relevant reporting period as set out in the prescribed format in the CL/FFP IT Solution, based on the annual financial statements, supplementary information and underlying accounting records.

Figures must be input into the cash flow statement schedule as follows:

- in the licensee's presentation currency;
- rounded to the nearest thousand (e.g. €1,234,567 should be entered as €1,235);
- all **cash inflow items must be input as positive figures** and **cash outflow items as negative figures**.

Cash Flow Statement	
Net cash inflow/(outflow) from operating activities other / non-split	<input type="text"/>
Net cash inflow/(outflow) from operating activities	<input type="text"/>
Cash flows from Investing Activities	
Cash receipts from sale of player registrations	<input type="text"/>
Cash (payments) from purchase of player registrations	<input type="text"/>
Cash receipts from sale of tangible fixed assets	<input type="text"/>
Cash (payments) from purchase of tangible fixed assets	<input type="text"/>
Cash inflow/(outflows) from investing activities other / non-split	<input type="text"/>
Cash inflow/(outflow) from investing activities	<input type="text"/>
Cash flows from financing activities	
Cash receipts from borrowings - shareholders & related party	<input type="text"/>
Cash (payments) on borrowings - shareholder & related party	<input type="text"/>
Cash receipts from borrowings - financial institutions	<input type="text"/>
Cash (payments) on borrowings - financial institutions	<input type="text"/>
Cash receipts from increase in capital/equity	<input type="text"/>
Cash (payments) on dividends paid to owners/shareholders	<input type="text"/>
Cash inflow/(outflows) from financing activities other / non-split	<input type="text"/>
Cash inflow/(outflow) from financing activities	<input type="text"/>
Other cash inflow/(outflow)	<input type="text"/>
Net cash inflow/(outflow) in reporting period	<input type="text"/>
Cash and cash equivalents reconciliation:	
Brought forward at start of reporting period	<input type="text"/>
Prior period adjustment / change of reporting perimeter (from previous reporting period)	<input type="text"/>
Net cash flow in reporting period	<input type="text"/>
Carried forward at end of period	<input type="text"/>
Cash and cash equivalents less Bank overdrafts in the Balance sheet	<input type="text"/>

Cash and cash equivalents reconciliation

The brought-forward amount of cash and cash equivalents (as per the cash flow statement), together with the net cash flow in the reporting period, should aggregate to the brought-forward amount of cash and cash equivalents (as per the cash flow statement). Only if applicable, the licensee may also use the line "prior period adjustment/change of reporting perimeter (from previous reporting period)".

In turn, the amount of cash and cash equivalents at the end of the reporting period (as per the cash flow statement schedule) will be checked against the equivalent items reported in the balance sheet schedule.

Cash equivalents are short-term, highly liquid investments held to meet short-term cash commitments rather than for investment or other purposes. Therefore, an investment normally qualifies as a cash equivalent only when it has a short maturity of, say, three months or less from the date of acquisition. Bank overdrafts are normally considered financing activities similar to borrowings. However, if they are repayable on demand and form an integral part of an entity's cash management, bank overdrafts are a component of cash and cash equivalents for the purposes of the cash flow statement.

APPENDIX V: GUIDANCE FOR BE PACKAGE – ADJUSTMENTS

A. Calculation of relevant income, relevant expenses and the break-even result – Article 58 and Annex X

Relevant income, relevant expenses and the break-even result for a reporting period are calculated based on the figures input into the profit and loss account schedule and the adjustment schedules.

	Relevant income – Annex X.A.1	Relevant expenses – Annex X.A.2
Relevant amounts for calculation of the break-even result	<ul style="list-style-type: none"> a) Revenue – Gate receipts b) Revenue – Sponsorship and advertising c) Revenue – Broadcasting rights d) Revenue – Commercial activities e) Revenue – UEFA solidarity and prize money f) Revenue – Other operating income g) Profit on disposal of player registrations (and/or income from disposal of player registrations) h) Excess proceeds on disposal of tangible fixed assets i) Finance income and foreign exchange result 	<ul style="list-style-type: none"> a) Expenses - Cost of sales/materials b) Expenses - Employee benefits expenses c) Expenses - Other operating expenses d) Loss on disposal and amortisation/impairment of player registrations (and/or costs of acquiring player registrations) e) Finance costs and dividends
Manual adjustments (if applicable), using adjustment schedules	<p><u>Relevant income must be decreased</u> if any of the elements a) to i) above include any of the items j) to o) below:</p> <ul style="list-style-type: none"> j) Non-monetary credits/income k) Income transaction(s) with related party(ies) above fair value l) Income from non-football operations not related to the club m) Income in respect of a player for whom the licensee retains the registration n) Credit in respect of a reduction of liabilities arising from procedures providing protection from creditors o) Profit on disposal of intangible assets other than player registrations 	<p><u>Relevant expenses must be increased</u> if any of the elements a) to f) above include:</p> <ul style="list-style-type: none"> g) Expense transaction(s) with related party(ies) below fair value h) Loss on disposal and amortisation/impairment of intangible assets other than player registrations <p><u>Relevant expenses must be decreased</u> if any of the elements a) to e) above include any of the items g) to m) below:</p> <ul style="list-style-type: none"> f) Expenditure on youth development activities g) Expenditure on community development activities h) Expenditure on women's football activities i) Non-monetary debits/charges j) Finance costs directly attributable to the construction and/or substantial modification of tangible fixed assets k) Costs of leasehold improvement l) Expenses of non-football operations not related to the club
Automatic adjustments excluded from break-even result Annex X.A.3	<ul style="list-style-type: none"> a) Profit on disposal of tangible fixed assets b) Tax income 	<ul style="list-style-type: none"> n) Loss on disposal and depreciation/impairment of tangible fixed assets o) Tax expense

The licensee must fully complete the disclosure requirements in each relevant schedule for each reporting period. Further guidance in respect of each of these schedules follows in this appendix.

Appropriate player accounting adjustments must also be made if a licensee opts to apply the capitalisation and amortisation method of player accounting for break-even information (instead of the income and expense method), or if its player accounting is not otherwise in accordance with the requirements set out by UEFA in the Regulations (Annex VII C).

Further adjustments may also be made to a licensee's relevant income and relevant expenses: (i) by the UEFA administration to reclassify amounts between account lines, with any such reclassifications having no impact on the break-even result ("FS reclassification"), and (ii) by the CFCB, based on the assessment of the monitoring

documentation, to make adjustments to certain account lines that will impact on the calculation of the break-even result (“BE correction”).

B. Transactions with related parties – Annex X B(l), C(f), (F)

In summary, there are three key steps for a licensee to undertake in respect of transactions between an entity in the reporting perimeter and a related party:

- i) For each entity that is included in the reporting perimeter, identify and disclose in the supplementary schedule in the BE package **all transactions with related parties** in a reporting period by considering each possible related-party relationship (disclosure about each related-party transaction must be done regardless of whether or not the licensee is doing an adjustment for the purpose of the break-even calculation).
- ii) Determine and disclose the **fair value of each related-party transaction** based on the circumstances of each transaction and evidence such as the club’s other similar transactions (current and historic) and comparable transactions of other clubs.
- iii) If the **fair value is different to the recorded value of a transaction**, then relevant income/expenses must be adjusted accordingly by inputting details to the adjustment schedule in the BE package (a downwards adjustment only in case of an income transaction; an upwards adjustment only in case of an expense transaction).

Note: For the purpose of the break-even calculation, as per Annex X.F, the licensee must apply certain adjustments in respect of the transfer of a player’s registration between clubs that are related parties.

1. Definition of a related party

The determination as to whether a relationship falls within one of the definitions in Annex X F can involve judgement focusing on the substance of a relationship and not merely its legal form.

For the BE package and the break-even calculation it is not sufficient for a licensee to simply rely on what, if anything, may have been disclosed in respect of related-party transactions in its audited annual financial statements.

Careful judgement is required to determine whether transactions are, in substance, between related parties. For example, in a series of transactions involving three or more parties in which two of the parties are related, it may be that, in substance, all the transactions should be seen as one overall arrangement between related parties.

In accordance with Annex X F paragraph 2:

A person or a close member of that person’s family (i.e. those family members who may be expected to influence or be influenced by that person in his or her dealings with the entity, including that person’s children and spouse or domestic partner, children of that person’s spouse or domestic partner, and dependants of that person or that person’s spouse or domestic partner) is related to a reporting entity if that person:

- a) has **control** or **joint control** over the reporting entity;
- b) has **significant influence** over the reporting entity; or
- c) is a member of the **key management staff** of the reporting entity or of a parent of the reporting entity.

In accordance with Annex X F, paragraph 3:

An entity is related to a reporting entity if any of the following conditions apply:

- a) the entity and the reporting entity are members of the same **group** (which means that each parent, subsidiary and fellow subsidiary is related to the others);
- b) the entity and the reporting entity are **controlled, jointly controlled, or significantly influenced** by the same **government or by the same party**;
- c) one entity has **significant influence** over the other entity;
- d) one entity is an **associate or joint venture** of the other entity (or an associate or joint venture of a member of a group of which the other entity is a member);
- e) both entities are **joint ventures** of the same third party;

- f) one entity is a **joint venture** of a third entity and the other entity is an associate of the third entity;
- g) the entity is **controlled** or **jointly controlled** by a person identified in paragraph 2;
- h) a person identified in paragraph 2(a) has **significant influence** over the entity or is a member of the **key management personnel** of the entity (or of a parent of the entity);
- i) the entity, or any member of a group of which it is a part, provides **key management personnel** services to the reporting entity.

Definition of terms:

Control is the power to govern the financial and operating policies of an entity so as to obtain benefits from its activities. Control may be gained by share ownership, statutes or agreement.

Joint control is the contractually agreed sharing of control over an economic activity, which exists only when the strategic financial and operating decisions relating to the activity require the unanimous consent of the parties sharing control (the venturers).

Significant influence is the ability to influence but not control financial and operating policy decision-making. Significant influence may be gained by share ownership, statutes or agreement. For the avoidance of doubt, a party or in aggregate parties with the same ultimate controlling party (excluding UEFA, a UEFA member association or an affiliated league) is deemed to have significant influence if it provides an amount equivalent to 30% or more of the licensee's total revenue in a reporting period.

Key management personnel are those persons having authority over and responsibility for planning, directing and controlling the activities of an entity, directly or indirectly, including but not limited to any director (executive or otherwise) of the entity.

A **group** is a parent and all its subsidiaries. A parent is an entity that has one or more subsidiaries. A subsidiary is an entity, including an unincorporated entity such as a partnership that is controlled by another entity (known as the parent).

Government refers to any form of government, including government agencies, government departments and similar bodies, whether local or national.

An **associate** is an entity, including an unincorporated entity such as a partnership, which is neither a subsidiary nor an interest in a joint venture and over which the investor has significant influence. In the definition of a related party, an associate includes subsidiaries of the associate and a joint venture includes subsidiaries of the joint venture. Therefore, for example, an associate's subsidiary and the investor that has significant influence over the associate are related to each other.

A **joint venture** is a contractual arrangement whereby two or more parties undertake an economic activity that is subject to joint control

Illustrative examples

The illustrative examples set out various scenarios of relationships between parties and the resulting identification of related-party relationships.

Example 1

- Person X has a family relationship with Person Y (e.g. Person X is the son of Person Y). The principle set out in the Regulations is that members of a family may be expected to influence or be influenced by each other.
- Person X controls the Licensee (e.g. Person X owns 100% of the Licensee).
- Person Y controls Entity B (e.g. Person Y owns 100% of Entity B).

Therefore, the following are a related party of the Licensee:

- Person X (Annex X F.2a);
- Person Y (F.2a); and
- Entity B (F.3g).

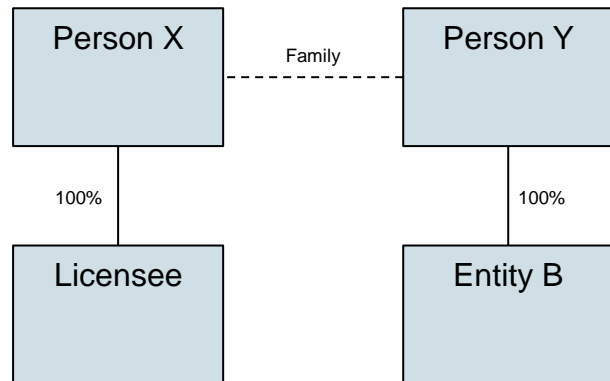

Example 2

- Person X has a family relationship with Person Y (e.g. Person X is the son of Person Y). The principle set out in the Regulations is that members of a family may be expected to influence or be influenced by each other.
- Person X controls the Licensee (e.g. Person X owns 100% of the Licensee).
- Person Y has significant influence over Entity B (e.g. Person Y owns 40% of Entity B).

Therefore, the following are a related party of the Licensee:

- Person X (Annex X F.2a);
- Person Y (F.2a); and
- Entity B (F.3h).

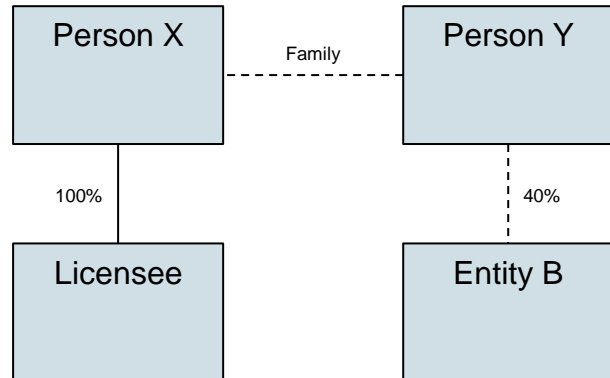

Example 3

- Person X controls the Licensee (e.g. Person X owns 100% of the Licensee).
- Person X is also a member of the key management staff of Entity C.
- Entity B controls Entity C (e.g. Entity B owns 100% of Entity C).

Therefore, the following are a related party of the Licensee:

- Person X (Annex X F.2a); and
- Entity C (F.3h).

Note: Entity B is not related to the Licensee.

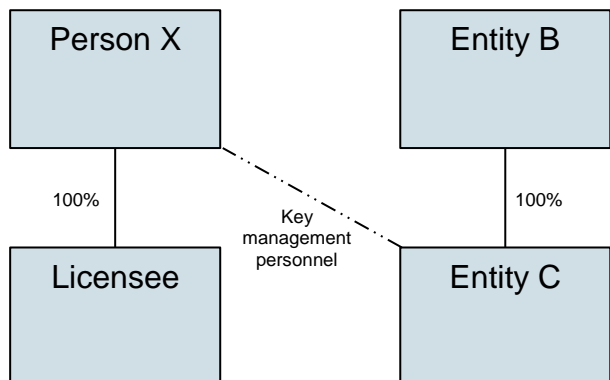

Example 4

- Person X controls the Licensee (e.g. Person X owns 100% of the Licensee).
- Person X also controls Entity B (e.g. Person X owns 100% of Entity B).

Therefore, the following are a related party of the Licensee:

- Person X (Annex X F.2a); and
- Entity B (F.3g).

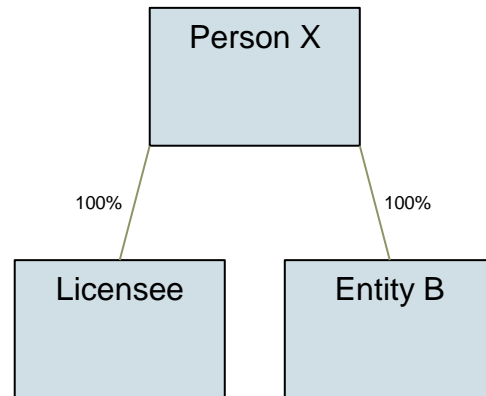
**Example 5**

- Person X controls the Licensee (e.g. Person X owns 100% of the Licensee).
- Person X also has significant influence over Entity B (e.g. Person X owns 40% of Entity B).

Therefore, the following are a related party of the Licensee:

- Person X (Annex X F.2a); and
- Entity B (F.3h).

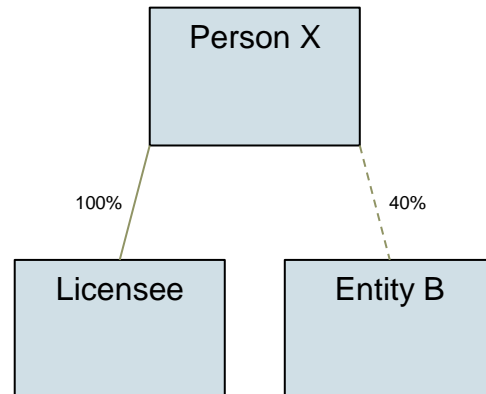
**Example 6**

- Person X has control over the Licensee (e.g. Person X owns 100% of the Licensee).
- Person Y has control over Entity B (e.g. Person Y owns 100% of Entity B).
- Person X and Person Y are not family members.
- Entity B provides an amount equivalent to 30% or more of the Licensee's total revenue in a reporting period (e.g. Entity B has a sponsorship agreement with the Licensee).

Therefore, the following are a related party of the Licensee:

- Person X (Annex X F.2a); and
- Entity B (F.3c).

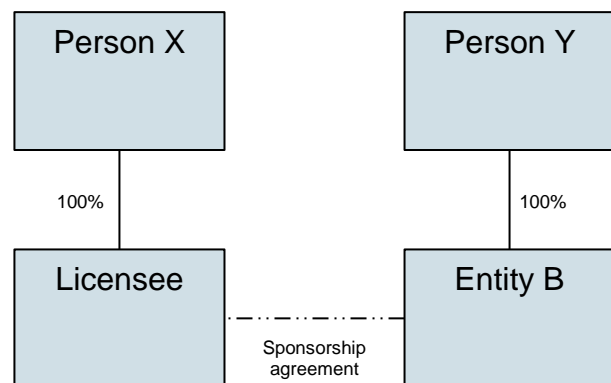

2. Related-party transaction

A **related-party transaction** is a transfer of resources, services or obligations between related parties, regardless of whether a price has been charged. A related-party transaction may, or may not, have taken place at fair value.

Examples of income transactions with a related party that require a licensee to demonstrate the estimated fair value of the transaction include:

- revenue from sponsorship arrangements;
- revenue from corporate hospitality tickets and/or use of executive boxes;
- any transaction with a related party whereby goods or services are provided by the club, and
- proceeds from a player transfer to a related party.

Examples of income transactions with a related party that are not relevant income (and, therefore, must be excluded from the calculation of the break-even result) include contributions from a related party such as:

- monies received as a donation; and
- debt waivers.

Contributions from a related party may only be taken into consideration in the determination of the acceptable deviation (as defined in Article 61) as part of the assessment of the break-even requirement.

Examples of expense transactions with a related party that require a licensee to demonstrate the estimated fair value of the transaction include:

- any expense transaction with a related party whereby goods and/or services are provided to an entity in the reporting perimeter;
- employee benefits expenses in respect of employees of entities outside of the reporting perimeter if these employees contribute to the activities of entities in the reporting perimeter;
- finance expense related to debt funding from a related party; and
- costs of acquisition for transfer of a player from a related party.

3. Fair value of transactions with related parties

Fair value is the amount for which an asset could be exchanged, or a liability settled, between knowledgeable willing parties in an arm's length transaction. An arrangement or a transaction is deemed to be 'not transacted on an arm's length basis' if it has been entered into on terms more favourable to either party to the arrangement than would have been obtained if there had been no related party relationship.

The best evidence of the fair value of a transaction is typically a price in a binding agreement in an arm's length transaction or a market price in an active market. If there is no binding agreement or active market, fair value should be based on the best information available to reflect the amount that an entity could obtain or would have to incur (as appropriate) at the transaction date in an arm's length transaction between knowledgeable willing parties.

In determining this amount, the licensee should also consider different types of evidence such as the process to arrive at a transaction (e.g. the details of offers from other parties), the outcome of similar transactions (historic and current arrangements), and similar transactions by comparable football clubs.

4. Adjustments for the break-even calculation

Income transaction(s) with related parties above fair value

- If a licensee has an income transaction from a related party that has been reported at an amount higher than the fair value, then the licensee must enter a **downward adjustment** for the purpose of calculating relevant income and the break-even result. Details should be disclosed in the supplementary schedule "transactions with related parties" (see 5 below).
- The excess of the actual income over the fair value amount can be recognised as a contribution and details should be disclosed in the contributions schedule "income transactions from a related party" – see **Appendix VI (B)**.

Expense transaction(s) with related party(ies) below fair value

- If a licensee has an expense transaction from a related party that has been reported at an amount lower than the fair value, then the licensee must enter an **upward adjustment** for the purpose of calculating relevant expenses and the break-even result. Details should be disclosed in the supplementary schedule "transactions with related parties" (see 5 below).
- The difference between the recorded amount and the fair value can be recognised as a contribution and details should be disclosed in the contributions schedule "capital contributions from a related party" – see **Appendix VI (B)**.

The requirement to adjust for transactions between an entity in the reporting perimeter and a related party exists irrespective of whether a price has been charged or not. In the second case, transactions are usually not included

in the accounting records (general ledger, cash book, sales ledger, etc.). For this reason and for the purpose of calculating this adjustment, any goods or services received or provided free of charge must be identified.

Transfer of a player's registration between clubs that are related parties

For the purpose of the break-even calculation, as per Annex X.F, the licensee must apply certain adjustments in respect of the transfer of a player's registration between clubs that are related parties.

Scenario 1:

Club A transfers a player to club B for € 200m. After six months, club B transfers the player to club C for €50m.

Clubs B and C are related parties. The player signed a two year contract with club B and then a two year contract with club C.

Break-even result: Since clubs B and C are related parties, they must calculate their break-even result in accordance with Annex X F(7).

- Club B must calculate the profit/loss on the player disposal using an amount for disposal proceeds that is the lower of (i) the actual transaction proceeds on disposal (€50m), and (ii) the net book value in respect of the costs of acquiring the player's registration in its financial statements (€150m).

It is a loss of €150 million so no adjustment is required for the break-even calculation for club B.

- Club C must calculate the amortisation based on the greater of (i) the acquisition costs €50m; (i.e. € 25m amortisation per year), and (ii) the historical cost of acquiring the player's registration in the financial statements of the club that has transferred-out the player €200m; (i.e. €100m amortisation per year).

The break-even result of club C will be adjusted with an additional amortization expense of €75m = (100-25).

Transaction(s) with related party(ies)

Select account line(s)	T-1-LC	Amount of RP transaction(s) recorded in the P&L	Fair Value of RP transaction(s)	complete supp. schedule	Explanation	Adjustment
<i>If an adjustment for a related party transaction (income/expense transactions) is reflected, this adjustment may be entered in the contribution schedule (.09 package only)</i>						
Amortisation of intangible fixed assets (player registrations)	-850	-25	-100		Transfer player XYZ from club B	-75
Total of transaction(s) with related party(ies)	-850	-25	-100			-75
			Adjustments			P&L

Scenario 2:

Club A has a player registration in his financial statements of €10m net book value (having originally acquired the player for €40m). Club A transfers the player to its related party club B for €100m.

Club A must calculate the profit/loss on the player disposal using an amount for disposal proceeds that is the lower of (i) the actual transaction proceeds on disposal (€100m), and (ii) the net book value in respect of the costs of acquiring the player's registration in its financial statements (€10m). The calculated profit on disposal is €zero, so an adjustment to the break-even result of €90m will neutralise the profit of club A from this transaction between related parties.

Club B must calculate the amortisation based on the greater of (i) the acquisition costs (€100m), and (ii) the historical cost of acquiring the player's registration in the financial statements of the club that has transferred-out the player (€40m). The break-even result of club B will not need to be adjusted.

Transaction(s) with related party(ies)

Select account line(s)	T-1-LC	Amount of RP transaction(s) recorded in the P&L	Fair Value of RP transaction(s)	complete supp. schedule	Explanation	Adjustment
<i>If an adjustment for a related party transaction (income/expense transactions) is reflected, this adjustment may be entered in the contribution schedule (.09 package only)</i>						
Profit on disposal of intangible fixed assets (player registrations)	258	90	0		profit from player XYZ to club B	-90
Total of transaction(s) with related party(ies)	258	90	0			-90
				Adjustments		P&L

5. Information to be disclosed

The licensee must disclose all transactions between an entity in the reporting perimeter and a related party, regardless of whether or not the licensee is making an adjustment for the break-even calculation.

The licensee must first disclose the following information:

- the profit and loss account line that contains the related-party transaction(s);
- the amount of the transaction(s) as recorded in the annual financial statements and underlying accounting records (in aggregate, if more than one related party transaction);
- the fair value of the transaction(s) (in aggregate, if more than one related-party transaction);
- brief explanatory comments about the transaction;
- the difference (i.e. adjustment), if any, between the recorded value and the fair value.

This information should be entered in the “Transaction(s) with related party(ies) schedule, as follows:

Transaction(s) with related party(ies)					
Name of related party	T-1-LC	Amount of RP transaction(s) recorded in the P&L	Fair Value of RP transaction(s)	Explanation	Adjustment
Total of transaction(s) with related party(ies)					

Secondly, for each account line containing one or more related-party transactions the licensee must also disclose further details for each related-party transaction, including:

- the name of the related party (being the name of the person or legal name of the entity, as appropriate);
- a description of the nature of the transaction;
- the amount of the transaction as recorded in the annual financial statements and underlying accounting records;
- the fair value of the transaction;
- the difference (i.e. adjustment), if any, between the recorded value and the fair value; and
- a summary of the different types of evidence to support the deemed fair value of the transaction.

The detailed transactions schedule must reconcile to the account line schedule.

This information should be entered in to the “Transaction(s) with related party(ies) – Detail” schedule, which is illustrated for Sponsorship and Advertising-Kit Sponsor below:

Transaction(s) with related party(ies) - Detail					
Name of related party	Nature of the transaction	Amount of RP transaction(s) recorded in the P&L	Fair Value of RP transaction(s)	Summary of evidence to support the fair value of the RP transaction	Adjustment (LC)
Sponsorship and Advertising-Main Sponsor					

The licensee is not required to disclose intra-group transactions that are eliminated on consolidation (or if applicable combination) if the consolidated results are being used as the basis for the submission for the profit and loss account schedule.

Transactions of a similar nature with a related party may be disclosed in aggregate, except where separate disclosure is necessary for an understanding of adjustments. Transactions with related parties with similar relationships with an entity may be disclosed in aggregate, unless a transaction is individually significant and/or separate disclosure is necessary for an understanding of adjustments. A significant transaction with a specific related party should not be concealed within an aggregated disclosure.

If the related-party transaction relates to the disposal of a tangible fixed asset, then the fair value adjustment is instead made through the schedule for excess proceeds on tangible fixed assets (see **Appendix V (H)**).

C. Non-monetary items – Annex X B(j) C(j)

1. Guidance

Appropriate adjustments must be made such that **non-monetary credits are excluded from relevant income** for the break-even calculation.

Appropriate adjustments may be made such that **non-monetary debits/charges are excluded from relevant expenses** for the break-even calculation.

Monetary items are defined as units of currency held and assets and liabilities to be received or paid in a fixed or determinable number of units of currency. The essential feature of a monetary item is a right to receive (or an obligation to deliver) a fixed or determinable number of units of currency.

Adjustments to exclude non-monetary items from the break-even calculation are expected to be rare because the typical income and expenses of football club activities are monetary items, other than depreciation/impairment of tangible fixed assets (which is excluded from the break-even calculation anyway) and amortisation/impairment of player registrations (for which there must not be exclusion adjustments for the break-even calculation).

For the avoidance of doubt:

- the amortisation and/or impairment of player registrations must be included in the break-even result as per Annex X.A.2(d) (i.e. there must not be adjustments to exclude amortisation and/or impairment of player registrations);
- the amortisation and/or impairment of intangible assets other than player registrations (such as goodwill) is a non-monetary debit/charge item that is automatically excluded anyway from the break-even result as per Annex X.A.3(b).

Revaluations of tangible and intangible assets/inventories do not meet the definition of monetary items as the revaluation of an asset does not result in an entity receiving the right to receive a fixed or determinable amount of cash or cash equivalents as a result of the revaluation process.

Similarly, write-backs of depreciation or amortisation charges in respect of fixed assets do not result in the entity receiving the right to receive a fixed amount of cash or cash equivalents, hence they are considered to be non-monetary items.

Conversely, the sale of goods and services by an entity (for example, the sale of a football season ticket) results in the entity receiving a fixed and determinable amount of cash from the customer, hence this is a monetary item.

A foreign exchange gain or loss will be classed as either a monetary or a non-monetary item, depending on whether the gain/(loss) is in respect of a monetary or a non-monetary item. For the avoidance of doubt, it does not depend on whether the foreign exchange gain or loss is realised or unrealised.

Foreign exchange gains/losses on monetary items – whether they are realised or unrealised – are monetary items and should be included in the break-even calculation.

Foreign exchange gains/losses on non-monetary items – whether they are realised or unrealised – are non-monetary items and should be excluded from the break-even calculation.

For example, it is typical accounting practice that if a club has a monetary debtor or creditor at the year-end (e.g. a transfer fee receivable or payable, debt/borrowings), the balances will be translated at the year-end exchange rate (or at the exchange rate of a related instrument, if appropriate). This will generate an unrealised gain or loss that will be reflected in the profit and loss account in the annual financial statements. In turn, such a gain or loss should be included in the break-even calculation as it is a monetary item because it relates to a monetary debtor or creditor. The treatment for the break-even requirement is to follow the accounting treatment.

Both the recognition of a **provision** for liabilities (debit/charge) and the release of a provision (credit/income) are monetary items.

2. Information to be disclosed

The licensee must identify each non-monetary credit and complete the adjustment schedule for each such item. The licensee may also identify non-monetary debits/charges, and may also include adjustment for any such items.

The following information must be disclosed for each non-monetary item to be adjusted by selecting the non-monetary items line in the profit and loss account schedule:

- the amount of the non-monetary item to be adjusted; and
- in the explanation cell, as a minimum, a description of the nature of each non-monetary item.

This information should be entered in the “Non-monetary items” schedule, which is illustrated below:

Non monetary items				
Select account line(s)	T-1-LC	Non-monetary amount	Explanation	Adjustment
Total Non monetary items				

D. Exclusion of income and/or expenses of non-football operations not related to the club - Annex X (B11 / C1m)

1. The meaning of non-football operations

The income and expenses of non-football operations are a distinguishable component of an entity that is engaged in providing an individual product or service or a group of related products or services that is subject to risks and returns that are different from those of the football club operations.

In some cases, an entity’s annual financial statements may include separate disclosure of income and expenses from football club operations, and income and expenses from non-football operations (such as from other sporting operations or from property development) within the notes to the accounts if this is a requirement under the relevant national law or accounting practice. However, the absence of separate quantification and disclosure of income and expenses from non-football operations in its annual financial statements does not necessarily mean that a club does not have non-football operations.

In determining whether or not there are non-football operations in the licensee’s reporting perimeter, the factors that should be considered include:

- the nature of the products and services and how they are branded and marketed to customers;
- the type or class of customer for the products or services;
- the methods used to distribute the products or provide the services;
- the nature of the regulatory environment;
- geographical location of operations;
- the quantitative contribution of operations relative to the football club operations, in terms of revenue, profit/loss and assets; and
- the way in which operating results are reviewed by the entity’s chief operating decision maker to make decisions about resources to be allocated to the operations and assess its performance.

2. The distinction between non-football operations related to the club and non-football operations not related to the club

Having determined that there are non-football operations within the reporting perimeter, the Regulations draw a distinction between:

- non-football activities/operations which are not related to the activities, locations or brand of the football club**, for which the income must be excluded from the break-even calculation and the expenses may be excluded from the break-even calculation; and
- non-football activities/operations which are related to the activities, locations and/or brand of the football club**, for which the income may be included in the break-even calculation if the corresponding expenses are also included.

In general, non-football operations which are related to the locations of the football club are operations physically based at or in close proximity to a club's home stadium and/or training facilities such as a hotel, restaurant, conference centre, business premises (for rental), health-care centre, or other sports teams. And, non-football operations which are related to the brand of the football club are operations clearly using the name/brand of a club as part of their operations at the location and in customer/marketing collateral.

A licensee must bear in mind the substance of the relationship between the non-football operations and the football club, including both the current and historical relationship, the history of the legal ownership of the non-football operations, the financing of the non-football operations (whether the development of a non-football operation has been financed from the football club's own resources or not), and the completeness of financial reporting of the non-football operations (all expenses).

3. Potential implications for the break-even calculation

For non-football operations not related to the club:

- Income from non-football operations not related to the club (i.e. not related to the football activities, locations or brand of the football club) must be excluded from the calculation of relevant income.
- The expenses of non-football operations not related to the club (i.e. not related to the football activities, locations or brand of the football club) may be excluded from the calculation of relevant expenses.

For non-football operations related to the club:

- Income from non-football operations related to the club (i.e. related to the activities, locations or brand of the football club) may be included in the calculation of the break-even result if the corresponding expenses are also included. In this case both must be included consistently from one reporting period to another.
- The expenses of non-football operations related to the club (i.e. related to the activities, locations or brand of the football club) must be included in the break-even calculation if the corresponding income is also included. In this case both must be included consistently from one reporting period to another.

If an entity which is included in the reporting perimeter has non-football operations, the following applies:

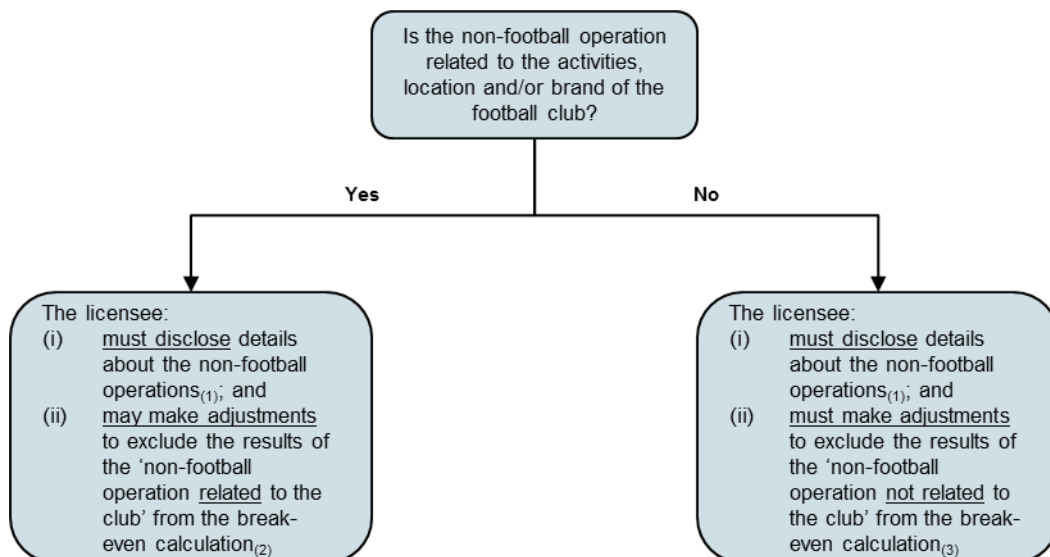

(1) The licensee must disclose certain information about each non-football operation that is part of an entity in the reporting perimeter, regardless of whether or not the licensee is making an adjustment for the break-even calculation.

(2) If a licensee's reporting perimeter does include an entity which has 'non-football operations related to the club' (e.g. other sports), then the licensee **may process exclusion adjustments** and thus decide to exclude results (all income and all expenses) of the 'non-football operations related to the club' for the purpose of the break-even calculation by using the adjustment schedule for "non-football operations". The

selected treatment (inclusion or exclusion) must be applied on a consistent basis from one reporting period to the next.

- (3) If a licensee’s reporting perimeter does include an entity which has some “non-football operations not related to the club”, then the licensee **must process exclusion adjustments** and thus exclude the income (and may exclude the expenses) of the “non-football operations not related to the club” for the purpose of the break-even calculation by using the adjustment schedule for “non-football operations” (see also **Appendix III D**).

4. Information to be disclosed

If the licensee processes exclusion adjustments for the break-even calculation, it has to use the “non-football operations” adjustment schedule to:

- select each of the relevant profit and loss account lines (the total value of the account line will be displayed);
- input the amount of income or expense to be adjusted; and
- provide any further explanatory commentary, to the extent not already disclosed in the detailed schedule as above.

Adjustments for non football operations				
Select account line(s)	T-1-LC	Non football operations	Explanation	Adjustment
Total non football operations adjustments				

Regardless of whether or not an adjustment is required or has been made for the break-even calculation, the licensee must disclose all non-football operations performed by an entity in the reporting perimeter.

A licensee must complete both parts of the supplementary schedule (Non-football operations – details, as shown below) to provide more detailed analysis and explanations covering both:

- non-football operations adjusted for break-even calculation, which are operations included in the reporting perimeter and for which the licensee is making some adjustments for the break-even calculation; and
- non-football operations not adjusted for break-even calculation, which are operations included in the reporting perimeter and for which the licensee is not making adjustments as the non-football operations are deemed to relate to the club in terms of activities, location and/or brand.

Non-football operations adjusted for break-even calculation								
Reporting period T-1					Is the operation is based at or in close proximity to stadium and/or training facilities?		Does the operation clearly uses the name/brand of the club?	
Description of the non-football operation	Revenue (LC)	Expenses in employee benefit expenses (LC)	Expenses in other account lines (LC)	Net result in reporting period - unadjusted (LC)	Enter '1' for yes	Enter '1' for no	Enter '1' for yes	Enter '1' for no

Non-football operations not adjusted for break-even calculation								
Reporting period T-1					Is the operation is based at or in close proximity to stadium and/or training facilities?		Does the operation clearly uses the name/brand of the club?	
Description of the non-football operation	Revenue (LC)	Expenses in employee benefit expenses (LC)	Expenses in other account lines (LC)	Net result in reporting period - unadjusted (LC)	Enter '1' for yes	Enter '1' for no	Enter '1' for yes	Enter '1' for no

E. Expenditure on youth development activities – Annex X C (g)

1. Information to be disclosed

If a licensee chooses to have an adjustment for expenditure on youth development activities, the following information must be disclosed in the appropriate schedule by selecting each line of the profit and loss account schedule that contains expenditure on youth development activities:

- the amount of directly attributable expenditure on youth development activities as contained within each selected line of the profit and loss account schedule; and
- in the explanation cell, any additional commentary considered necessary to assist understanding of the adjustment.

This adjustment schedule is shown below:

Expenditure on youth development activities				
Select account line(s)	T-1-LC	Expenditure on YDA	Explanation	Adjustment
Total of expenditure on youth development activities				

The further level of detail required for expenditure on youth development activities (enter expenses as negative figures, rounded to the nearest thousand) is illustrated below.

Expenditure on youth development activities	
	T-1 Expenditure on YDA
Expenditure on youth development activities	
Employee Benefits expenses for employees wholly involved in youth development activities	
Employee Benefits expenses for youth players (under the age of 18)	
Accommodation costs	
Medical fees	
Educational fees	
Travel	
Subsistence	
Kit, clothing and equipment	
Facility costs	
Other costs directly attributable to youth development activities	

If a licensee outsources youth development activities to an entity outside of the reporting perimeter, then the licensee will still be required to disclose the breakdown of expenditure if it chooses to have an adjustment for expenditure on youth development expenses.

Costs of employee benefits for employees who are youth players aged 18 or over as at the statutory closing date of the licensee cannot be excluded from relevant expenses. This age criterion provides an objective way to ensure consistency between all clubs and licensors. On the other hand, the costs of employee benefits for a player who is aged under 18 as at the statutory closing date of the licensee and who plays in the first team can be excluded from the break-even calculation.

F. Expenditure on community development activities – Annex X C (h)

1. Information to be disclosed

If a licensee chooses to have an adjustment for expenditure on community development activities, then the following information must be disclosed in the appropriate schedule by selecting each line of the profit and loss account schedule that contains expenditure on community development activities:

- the amount of directly attributable expenditure on community development activities as contained within each selected line of the profit and loss account schedule; and
- in the explanation cell, any additional commentary considered necessary to understand the adjustment.

This adjustment schedule is shown below:

Expenditure on community development activities				
Select account line(s)	T-1-LC	Expenditure on CDA	Explanation	Adjustment
Total of expenditure on community development activities				

The further level of detail required for expenditure on community development activities (enter expenses as negative figures, rounded to the nearest thousand) is illustrated below.

Expenditure on community development activities		T-1 Expenditure on CDA
Expenditure on community development activities		
Employee Benefits expenses for employees wholly involved in community development activities		
Travel		
Subsistence		
Equipment		
Facility costs		
Other costs directly attributable to community development activities		
Donations to other entities for community development activities		

G. Expenditure on women’s football activities – Annex X C (i)

1. Information to be disclosed

If a licensee chooses to have an adjustment for expenditure on women’s football activities, the following information must be disclosed in the appropriate schedule by selecting each line of the profit and loss account schedule that contains expenditure on women’s football activities:

- the amount of directly attributable expenditure on women’s football activities as contained within each selected line of the profit and loss account schedule; and
- in the explanation cell, any additional commentary considered necessary to understand the adjustment.

This adjustment schedule is shown below:

Expenditure on women's football				
Select account line(s)	T-1-LC	Expenditure on WF	Explanation	Adjustment
Total of expenditure on women's football				

The further level of detail required for expenditure on women’s football activities (enter expenses as negative figures, rounded to the nearest thousand) is illustrated below.

Expenditure on women's football	
	T-1 Expenditure on WF
Women's football	
Employee Benefits expenses for employees wholly involved in women football activities	
Employee Benefits expenses for women players	
Accommodation costs	
Medical fees	
Educational fees	
Travel	
Subsistence	
Kit, clothing and equipment	
Facility costs	
Other costs directly attributable to women football activities	

H. Excess proceeds on disposal of tangible fixed assets – Annex X A (h)

1. Guidance

Guidance for treatment of disposals of tangible fixed assets for the break-even calculation

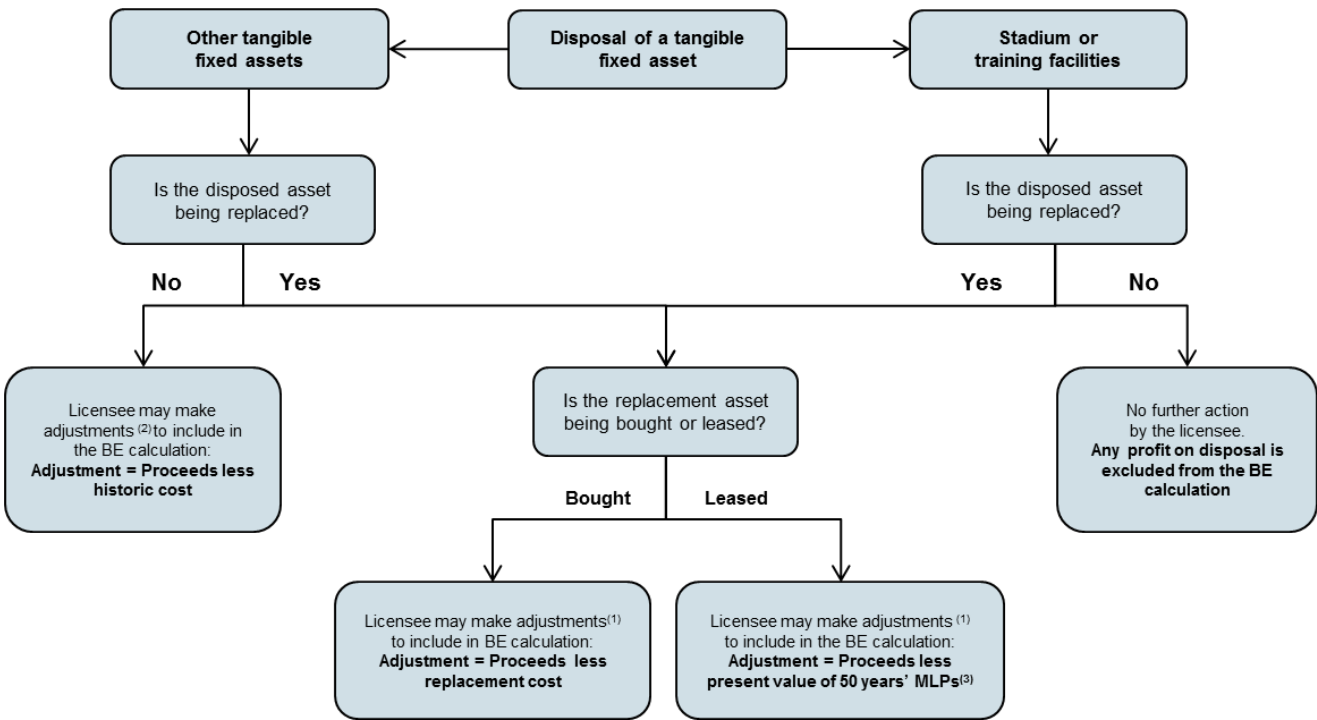

- (1) Where a disposed asset is being replaced, an adjustment to include an amount in relevant income in the break-even calculation is to be processed using the supplementary schedule for “excess proceeds on disposal of tangible fixed assets (asset being replaced)”. The adjustment cannot exceed the profit on disposal recognised in the audited financial statements.
- (2) Where a disposed asset other than a club’s stadium or training facility is not being replaced, an adjustment to include an amount in relevant income in the break-even calculation is to be processed using the supplementary schedule for “excess proceeds on disposal of tangible fixed assets (other asset not being replaced)”. The adjustment cannot exceed the profit on disposal recognised in the audited financial statements.
- (3) Reference to “present value of 50 years’ MLPs” refers to the present value of 50 years’ minimum lease payments as defined in the Regulations

2. Timing of initial recognition of excess proceeds on disposal of tangible fixed assets

Excess proceeds on the disposal of tangible fixed assets should be included as relevant income in the same reporting period in which the profit (or loss) on disposal of the relevant asset(s) is recorded in the annual financial statements.

3. Stadium and training facilities

Stadium means the venue for a competition match including, but not limited to, all properties and facilities near to such stadium (for example, offices, hospitality areas, press centre and accreditation centre).

Training facilities means the venue(s) where a club's registered players undertake football training and where youth development activities take place on a regular basis.

For the avoidance of doubt, if a stadium or training facilities asset is disposed of and is not being replaced, any profit on disposal must be excluded from the calculation of the break-even result and there must not be an excess proceeds adjustment.

4. Net proceeds on disposal

Net proceeds on disposal is the consideration received/receivable at the time of sale in exchange for the asset being disposed of.

For the avoidance of doubt, and as set out in the Annex X B (1)(j) for the calculation of relevant income and relevant expenses, if a tangible fixed asset is disposed of to a related party, the proceeds on disposal must reflect the fair value of any such transaction. The fair value of the asset disposed of should be determined and demonstrated by management. The best evidence of the fair value of a transaction is typically a price in a binding agreement in an arm's length transaction or a market price in an active market. The fair value of land and buildings (such as stadiums and training facilities) is usually determined from market-based evidence by an appraisal undertaken by independent professionally qualified valuers.

5. Historical cost of the asset

Historical cost is the amount of cash or cash equivalents paid, or the fair value of the other consideration given, to acquire an asset at the time of its acquisition or construction. The historical cost of an acquired asset comprises the purchase price (including import duties and non-refundable purchase taxes, after deducting trade discounts and rebates) and any directly attributable costs of bringing the asset to the location and condition necessary for it to be capable of operation.

6. Full cost of the replacement asset

Full cost of the replacement asset includes all costs to acquire or construct the new asset and bring it to the location and condition necessary for it to be capable of operation, as a replacement for the asset disposed of.

If the full cost of the replacement asset is an estimate (because part or all of the costs have yet to be incurred), the licensee should prudently estimate the full replacement cost of the asset based on information and evidence that is available at that time of submission of the break-even documentation. Subsequently, any material change to the full cost of the replacement asset that would have resulted in a materially different amount being recognised as excess proceeds on disposal of tangible fixed assets had it been known at the time of preparation of the schedule must be notified to the licensor/CFCB.

7. Present value of 50 years' minimum lease payments

For the purposes of the break-even requirement, if the replacement asset is to be leased, the Annex X B (1)(g) require the licensee to calculate a figure that is equivalent to the present value of the sum of 50 years' minimum lease payments.

The present value of the minimum lease payments in any given year can be calculated as follows:

$$PVMLP = MLP / ((1+BR)^N)$$

Where: PVMLP = the present value of the minimum lease payment in a given year

MLP = minimum lease payment in a given year

BR = borrowing rate, as a decimal and representing the interest rate implicit in the lease

^ = to the power of

N = the year of the lease payment

Illustrative example:

Year (N)	Minimum lease payment (MLP)	Borrowing rate (BR)	Discount factor		PVMLP €000
1	100	0.05	$1/(1+0.05)^1$	0.952	95
2	100	0.05	$1/(1+0.05)^2$	0.907	91
3	100	0.05	$1/(1+0.05)^3$	0.864	86
4	100	0.05	$1/(1+0.05)^4$	0.823	82
5	100	0.05	$1/(1+0.05)^5$	0.784	78
.....
50	100	0.05	$1/(1+0.05)^{50}$	0.087	9
Present value of 50 years' minimum lease payments			1,826		

- The present value of minimum lease payments should be calculated using the interest rate implicit in the lease.
- If the interest rate implicit in the lease is not determinable, the licensee's incremental borrowing rate should be used. The incremental borrowing rate is the rate of interest the licensee would have to pay on a similar lease or, if that is not determinable, the rate that, at the inception of the lease, the licensee would incur to borrow over a similar term, and with a similar security, the funds necessary to purchase the asset. Generally, most lease arrangements are secured, and therefore a secured loan rate would normally be appropriate.
- If the quantum of lease payments are wholly or partly to be determined based on another variable (e.g. revenue, match attendances), the minimum lease payment for each year should be based on reasonable assumptions.
- If the quantum of minimum lease payments is not specified in the lease arrangements for a full 50 years, management should apply a reasonable assumption for the quantum of lease payments for each of the missing years so that the calculation does cover a full 50 years. For example, it may be reasonable to assume that the quantum of the minimum lease payment for each year after the final year for which the lease payment is specified should be equivalent to the quantum in that final year.
- Subsequently, any material change to the present value of minimum lease payments that would have resulted in a materially different amount being recognised as excess proceeds on disposal of tangible fixed assets had it been known at the time of preparation of the schedule must be notified to the licensor/CFCB.

8. Information to be disclosed

As appropriate, the licensee must complete the adjustment schedule for excess proceeds on disposal of tangible fixed assets (asset being replaced) and/or excess proceeds on disposal of tangible fixed assets (other asset not being replaced). Both schedules are illustrated below:

Excess proceeds on disposal of tangible fixed assets- being replaced							
	T-1-LC	Profit on disposal of asset	Proceeds from disposal	Replacement asset - full cost	Replacement asset - minimum lease payments	Adjustment	Explanation
Excess proceeds on Disposal of Tangible Fixed Assets							
Total Excess proceeds on disposal of tangible fixed assets- being replaced							

Excess proceeds on disposal of tangible fixed assets- other not being replaced							
	T-1-LC	Profit on disposal of asset	Proceeds from disposal	Historical cost	Adjustment	Explanation	
Excess proceeds on Disposal of Tangible Fixed Assets							
Total Excess proceeds on disposal of tangible fixed assets- other not being replaced							

The following information must be disclosed for each transaction by selecting the account line for profit/loss on disposal of tangible fixed assets:

- the figure for the profit on disposal of the asset, being the amount recorded in the annual financial statements for the reporting period in respect of the specific asset, as included in the profit/loss on disposal of tangible fixed assets profit and loss account line;
- the figure for the proceeds on disposal of the asset; if the disposal was to a related party, this figure must reflect the fair value of the asset disposed of;

- for an asset other than stadium/training that is not being replaced, the historical cost of the asset;
- as applicable, in respect of the replacement asset (if any), the figure for either the full replacement cost or the present value of 50 years' minimum lease payments;
- the excess proceeds adjustment, determined as:
 - for an asset that is being replaced, the lower of profit on disposal and proceeds less replacement cost or proceeds less the present value of 50 years' minimum lease payments (as applicable);
 - for an asset other than stadium/training that is not being replaced, the lower of profit on disposal and proceeds less historic cost;
- in the explanation cell, as a minimum:
 - a description of the disposed asset;
 - whether the disposal was to a third party or a related party;
 - if the disposal was to a related party, the identity of the related party (being the full name of the person or full legal name of the entity, as appropriate), the recorded amount and the fair value amount; and
 - if the asset is being replaced, a description of the replacement asset, development status, commentary on the cost of replacement or lease arrangements.

Illustrative examples

Example 1:

A club disposes of a tangible fixed asset that is neither a football stadium nor training facilities and the asset will not be replaced. Proceeds for the disposed asset are €3m. The historical cost of the asset was €1m and at the time of disposal it was recorded in the financial statements at a net book value of €0.6m.

Profit on disposal of asset in the financial statements	Proceeds less historic cost
Calculation: Proceeds: €3m Net book value: €0.6m Profit: €2.4m	Calculation: Proceeds: €3m Historical cost: €1m Balance: €2m
Outcome: amount to be included in the break-even calculation = €2m	

Example 2:

A club disposes of its old stadium, receiving net proceeds of €75m. The historical cost of the stadium was €40m and at the time of disposal it was recorded at a net book value of €15m. The club buys/develops a new stadium as a replacement asset, which costs €65m.

Profit on disposal of asset in the financial statements	Proceeds less replacement cost
Proceeds: €75m Net book value: €15m Profit: €60m	Proceeds: €75m Replacement cost: €65m Proceeds less replacement cost: €10m
Outcome: amount to be included in the break-even calculation = €10m	

Example 3:

A club disposes of its old stadium, receiving net proceeds of €30m. The historical cost of the stadium was €20m and at the time of disposal it had a net book value of €5m. The club leases a new stadium as a replacement asset, for which it has an annual minimum lease payment of €1m for 100 years. The interest rate (i.e. discount factor) is 5%.

Profit on disposal of asset in the financial statements	Proceeds less present value of 50 years' minimum lease payments
Calculation: Proceeds: €30m Net book value: €5m Profit: €25m	Calculation: Proceeds: €30m 50 years' MLPs: €1,000 x 50 = €50m Present value of 50 years' MLPs: €18.3m Proceeds less PV of 50 years' MLPs: €11.7m
Outcome: amount to be included in the break-even calculation = €11.7m	

I. Finance costs directly attributable to the construction and substantial modification of tangible fixed assets – Annex X C (k)

1. Guidance

A licensee may exclude from the calculation of the break-even result any finance costs that are directly attributable to the construction and/or substantial modification of an asset for use for the club's football activities, provided the finance costs have been expensed in a reporting period rather than capitalised as part of the cost of the asset, up until the asset is ready for use.

The amount that may be adjusted is the actual interest expense (not otherwise capitalised) less any investment income on the temporary investment of the amount borrowed to which the interest relates. The relevant interest is from the date when the entity incurs expenditure for the asset, incurs borrowing costs and undertakes activities that are necessary to prepare the asset for its intended use or sale, until the date of completion of the asset.

After completion of the construction and/or substantial modification of an asset, all finance costs must be included in the calculation of the break-even result.

2. Relevant finance costs

Adjustable finance costs are those finance costs that would have been avoided had the expenditure on the qualifying asset not been made. When funds are borrowed specifically for the purpose of acquiring, constructing and/or substantially modifying a qualifying asset, the amount of adjustable finance costs corresponds to the actual finance costs incurred on those funds during the relevant period. When a qualifying asset is funded from a pool of general borrowings, the amount of the adjustable finance costs should be determined by applying an appropriate interest rate to the expenditure on the qualifying asset.

A **qualifying asset** is an asset for the club's football activities that necessarily takes a substantial period of time to prepare for its intended use, which will usually be a stadium or football training facilities. Examples of substantial modification of a qualifying asset include the construction of an extension to an existing stand in a stadium, or the addition of a new roof to an existing stand.

The **financing arrangements** may result in specific borrowings being drawn down prior to some or all of the funds being utilised to finance the qualifying asset. In such circumstances, any investment income earned on the temporary investment of the funds, pending their expenditure on the qualifying asset, should be deducted for the adjustment calculation.

For the avoidance of doubt, if the entity adopts accounting treatment such that it capitalises finance costs as part of tangible fixed assets in its annual financial statements, no further adjustment is required for the calculation of the break-even result.

3. Commencement date and end date for the calculation of the adjustment

The **commencement date for the adjustment calculation** is the date when all three conditions (as set out in the Regulations) are first met, being (i) the licensee incurs expenditure for the asset, and (ii) incurs borrowing costs, and (iii) undertakes activities that are necessary to prepare the asset for its intended use or sale. Activities that are necessary to prepare the asset for its intended use include initial technical and administrative work, such as activities associated with obtaining permits, prior to the commencement of the physical construction/substantial modification of the asset. The mere holding of an asset, without any associated development activities, does not entitle an entity to make an adjustment for related finance costs, for example, the holding of land that is not undergoing activities necessary to prepare it for its intended use.

The adjustment calculation should generally continue for as long as the three above-listed conditions are met. If, however, the entity suspends development-related activities for an extended period, inclusion of the finance costs in the adjustment calculation should also cease until such time as activities resume. Such development interruptions may occur, for example, due to cash flow difficulties or a desire to hold back development, in which case the finance costs incurred during the interruption are not considered to be a necessary development cost and therefore cannot be included in the adjustment. On the other hand, finance costs incurred during temporary delays that are necessary or expected in the process of getting an asset ready for its intended use, or which result from a natural delay such as adverse weather conditions that are common to the location, can be included in the adjustment.

For the adjustment calculation, **finance costs should cease to be included in the adjustment** when substantially all of the activities necessary to prepare the qualifying asset for its intended use are complete. An asset is normally ready for its intended use when the physical construction of the asset is complete, even when

routine administrative work continues. If minor modifications are all that are still outstanding, this indicates that substantially all the activities are complete.

4. Information to be disclosed

The following information must be disclosed in the adjustment schedule for finance costs directly attributable to the construction and/or substantial modification of tangible fixed assets by selecting the finance costs line in the profit and loss account schedule:

- the amount of adjustable finance costs, being finance costs directly attributable to the construction of tangible fixed assets as defined in the Annex X C (k);
- In the explanation cell, as a minimum:
 - a description of the qualifying asset;
 - the commencement date for the adjustment calculation;
 - the end date for the adjustment calculation or disclosure “asset not completed at statutory reporting date”; and
 - whether the funds are borrowed specifically for the purpose of acquiring, constructing and/or substantially modifying a qualifying asset, or funded from a pool of general borrowings.

This information should be entered in to the “Finance costs directly attributable to tangible fixed assets” schedule, which is illustrated below:

Finance costs directly attributable to tangible fixed assets				
	T-1-LC	Finance costs	Explanation	Adjustment
Finance expenses				
Total finance costs directly attributable to tangible fixed assets				

J. Costs of leasehold improvement – Annex X C (l)

1. Guidance

A licensee may exclude from the calculation of the break-even result subsequent construction and/or substantial modification costs it has incurred on a tangible fixed asset that has been leased for at least ten years if such costs: (i) can be measured reliably, (ii) will result in future economic benefits to flow to the licensee, (iii) are not otherwise capitalised.

For the avoidance of doubt, the break-even result must include day-to-day servicing and regular maintenance costs in relation to specific items of property, plant or equipment. Any such costs should be accounted for in the profit and loss account.

Those licensees which do not capitalise leasehold improvements and meet the criteria outlined above may exclude such costs from the break-even result by completing the adjustment schedule shown below. Within the explanation, the licensee must disclose the length of the original lease and the remaining term of the lease as at the end of the reporting period.

For the avoidance of doubt, for those licensee which do capitalise leasehold improvements, the depreciation charge in the profit and loss account is automatically adjusted to exclude depreciation costs from the break-even result, and therefore no further adjustment is required for the calculation of the break-even result.

Examples of leasehold improvements include the construction of executive boxes or the addition of new seats.

2. Information to be disclosed

Cost of leasehold improvement				
Select account line(s)	T-LC	T Cost of leasehold	Explanation	Adjustment
Total cost of leasehold improvement				

K. Player transfers adjustments: UEFA requirements for player accounting (Annex X C (d)) and Income in respect of a player for whom the licensee retains the registration (Annex X B (m))

1. Guidance

There are two types of player transfers adjustments:

(i) UEFA requirements for player accounting

To meet the requirements of the Regulations, a licensee that uses the income and expense method in its annual financial statements and elects to apply the capitalisation and amortisation method for the purposes of the break-even calculation must apply certain minimum accounting requirements as described in Annex VII C(4) and prepare a player identification table as described in Annex VI F for each relevant reporting period, that may be requested by the licensor and/or CFCB.

A licensee that uses the capitalisation and amortisation method in its annual financial statements but does not apply the minimum accounting requirements as described in Annex VII C must make appropriate adjustments for the calculation of the break-even result,

(ii) Income/profit in respect of a player for whom the licensee retains the registration

As detailed in the “Player transfers” section (**Appendix IV, B (13)**) an adjustment must be made for any income/profit in respect of a player for whom the licensee retains the registration.

For the avoidance of doubt, any income/profit arising from the disposal of a player’s economic rights can only be included as relevant income for the calculation of the break-even result following the permanent transfer of the player’s registration to another club. An adjustment must be made to exclude any profit on disposal generated while the licensee retains the registration. Then when the player registration is disposed of in its entirety, an adjustment may be made to recognise the full profit, including the amount initially deferred.

For example, during its reporting period ending 2015, Club A disposes of 50% of the economic rights of Player X for a profit of €1m, but retains the player’s registration. For break-even purposes, the licensee must make an adjustment to exclude the profit on disposal for the reporting period ending 2015. During its reporting period ending 2016, Club A disposes of the remaining 50% of the economic rights of Player X for a profit of €1m and permanently transfers the player’s registration to another club. For break-even purposes, the licensee must make an adjustment to recognise profit on the disposal of €2m for the reporting period ending 2016.

2. Information to be disclosed

To make any of the adjustments detailed above, the licensee must complete the “Player accounting adjustments” schedule, as shown below.

For the adjustments for UEFA requirement for player accounting, the licensee should follow the steps outlined in the table below:

Ref	Account line description	Source of adjustment figure
P2600	Amortisation of intangible assets (players)	Amortisation expense figure as calculated from player identification table
P2605	Impairment of intangible assets (players)	Impairment expense figure as calculated from player identification table

Ref	Account line description	Source of adjustment figure
P2610	Profit on disposal of intangible assets	Profit figure, as calculated from player identification table
P2620	Loss on disposal of intangible assets	Loss figure, as calculated from player identification table
P2700	Cost of acquiring player registrations	To adjust to zero
P2710	Income from disposal of player registrations	To adjust to zero

For the adjustments for a licensee which uses the capitalisation and amortisation method but does not apply the minimum accounting requirements as described in Annex VII C, then it must make appropriate adjustments for the calculation of the break-even result by completing the player accounting adjustment schedule.

For the adjustment for income/profit in respect of a player for whom the licensee retains the registration, a negative figure should be entered for any income/profit to be excluded from the break-even result. In the “Explanation” cell the licensee should include the player’s name and the level of any player’s economic rights that have been disposed of. Then, when the player registration is disposed of in its entirety, an adjustment may be made to recognise the full profit, including the amount initially deferred, by entering a positive figure in whichever income (P2710) or profit (P2610) line was used for the initial adjustment. In the “Explanation” cell, the licensee should include the player’s name and a disclosure that the registration has been disposed of.

Player accounting adjustments				
Select account line(s)	T-1-LC	Alternative method- player acc	Explanation	Adjustment
Amortisation of intangible fixed assets (player registrations)				
Impairment of intangible fixed assets (player registrations)				
Profit on disposal of intangible fixed assets (player registrations)				
Loss on disposal of intangible fixed assets (player registrations)				
Cost of acquiring player registrations (including non capitalised agent fees and loan fees)				
Income from disposal of player registrations (including loan income)				
Total player accounting adjustments				

L. Credit in respect of a reduction of liabilities arising from procedures providing protection from creditors – Annex X B (n)

1. Guidance

If a licensee’s profit and loss account includes a credit/income amount in respect of a reduction of liabilities arising from procedures providing protection from creditors, the licensee must make an adjustment to effectively exclude the credit/income amount from the break-even calculation.

For the purpose of this adjustment, procedures providing protection from creditors means any form of procedures providing protection from creditors pursuant to relevant laws or regulations, including procedures that may be referred to as administration procedures, bankruptcy, liquidation and insolvency.

As a result of such procedures, a licensee may benefit from a reduction of liabilities (i.e. the amount due from a licensee to creditors is reduced) and thereby recognise a credit/income in its profit and loss account. For the purpose of the break-even calculation, the required exclusion adjustment means the licensee’s break-even result will not benefit from any such credit/income.

2. Information to be disclosed

The licensee must select the relevant line of the profit and loss account that contains the credit/income and enter to the adjustment schedule:

- the amount of the adjustment for any credit in respect of a reduction of liabilities arising from procedures providing protection from creditors; and

- in the “Explanation” cell, additional explanatory information, including a brief description of the nature and timing of the procedures providing protection from creditors and the identity of the entity(ies) within the reporting perimeter that was/were subject to the procedures.

Credit arising from procedures providing protection from creditors				
Select account line(s)	T-1-LC	T-1 credit from procedures	Explanation	Adjustment
Total credit arising from procedures providing protection from creditors				

M. Adjustment relating to settlement agreements

Those licensees subject to settlement agreements may be required to make financial contributions. For the break-even calculation, a licensee may make an adjustment to exclude the cost of financial contributions from relevant expenses using the following adjustment schedule.

Adjustment related to settlement agreements				
Select account line(s)	T-1-LC	T adj related to SA	Explanation	Adjustment
Total adjustment related to settlement agreements				

The revenue from UEFA distributions should be recognised in the break-even calculation as normal, as explained in **Appendix IV (B5)**.

APPENDIX VI: GUIDANCE FOR BE PACKAGE – THE BE.09 PACKAGE

If a licensee exhibits any of the conditions described by indicators 1 to 6 of Article 62, or if otherwise requested by the CFCB, it will be required to complete and submit by the relevant deadline the BE.09 package, containing the information outlined in **Section 5.1.2**.

A. Break-even information for reporting period T

The figures to be input into the BE.09 package for reporting period T must be based on and reconcile to the relevant financial statements and/or underlying accounting records.

For the submission of BE.09 package in October, whether the break-even information is based on historic or a combination of historic and budgeted figures, and whether the information is based on audited or unaudited financial information, depends on the end date of a licensee's reporting period T.

The timing of submission of the break-even information for reporting period T will depend on the end date of a licensee's reporting period T.

- **For licensees with a reporting period T ending on or before 31 July**
 - At the time of submission in October the break-even information will be based on historic financial statements that must have been audited.
 - When the break-even information for reporting period T is prepared and submitted, the licensee must enter "1" to confirm that the figures are based on audited annual financial statements.
- **For licensees with a reporting period T ending after 31 July (but no later than the following 31 December)**
 - At the time of submission in October the break-even information will be based on a combination of historic figures (that may be unaudited) and budgeted figures.
 - For example, a licensee with reporting period T ending on 31 December 2018 will submit at the time of first submission in October 2018 the break-even information that will be based on a combination of historic figures (say, eight months to 31 August 2018) and budgeted figures (say, four months to 31 December 2018).
 - Subsequently (by no later than the following March deadline), the licensee must submit updated break-even information for T based on historic financial statements that must have been audited.
 - The licensor will set the deadline for submission and, in turn, the validated monitoring documentation must be submitted to the UEFA administration by no later than the set deadline. (
 - If the figures for reporting period T are a combination of historic and budgeted figures, in the profit and loss account and cash flow statement schedules the licensee must enter the number of months for which the figures are actual/historic and the number of months for which the figures are budgeted.

T-1-LC	T-ACT-LC	T-BUD-LC	T-LC
			Please enter 1 in the pink cell to confirm that these amounts are audited
Number of months:		Number of months:	
▶ 9 ▶		▶ 3 ▶	▶ ▶ ▶

- The licensee may separately disclose the figures for the actual/historic months (based on the appropriate accounting records) and the budgeted figures for the remaining months (based on management's budget information). The figures in the balance sheet schedule will be based on management's budget information.
- When the updated break-even information for reporting period T is prepared and submitted, the licensee must enter "1" to confirm that the figures are now based on audited annual financial statements. The licensee must enter the actual/historic figures in all relevant schedules based on the audited annual financial statements and underlying accounting records.

T-1-LC	T-ACT-LC	T-BUD-LC	T-LC
Please enter 1 in the pink cell to confirm that these amounts are audited			
Number of months:		Number of months:	
12		1	

- For the avoidance of doubt, when the updated break-even information is submitted for reporting period T based on audited annual financial statements, there should be no figures entered in the budgeted columns in the profit and loss account and cash flow statement schedules.

B. Contributions from equity participants and/or related parties – Annex X E and Article 61

1. Definition of contributions

- i) **Share capital increase from equity participants:** payments for shares through the share capital or share premium reserve accounts (i.e. investing in equity instruments in their capacity as a shareholder), less capital reductions.
- ii) **Gifts/donations received from a related party:** that is an unconditional gift made to the reporting entity by a related party which increase the reporting entity's equity without any obligation for repayment or to do anything in consideration for receiving them. For example, a waiver of inter-company or related-party debt constitutes a capital contribution, as it results in an increase in equity.
- iii) **Income transactions from a related party:** the amount to be considered as a contribution will be no more than an amount equivalent to the difference between the actual income in a reporting period and the fair value of the transaction(s) in a reporting period as already recognised in the calculation of the break-even result (see part B(1)(k)).

The cash or goods must have been received by the reporting entity, as opposed to just some form of promise or commitment from the equity participants and/or the related party.

The following types of transaction are **not** "contributions from equity participants and/or related parties":

- positive movement in net assets/liabilities arising from a revaluation;
- a creation or increase in the balance of other reserves where there is no contribution (either in cash or cash equivalents) from equity participants;
- a transaction whereby the reporting entity has a liability in that the entity has a present obligation to act or perform in a certain way;
- contributions from owners in respect of instruments classified as liabilities.

Regardless of the recognition of contributions in an entity's annual financial statements, the amount that can be recognised for the purpose of the break-even requirement must be no greater than the monetary value for the entity. For the avoidance of doubt, an intention or commitment to make a contribution is not sufficient for a contribution to be taken into consideration, and the entity cannot be required to repay the cash or other resources received.

2. Timing of contributions (Article 61)

Contributions from equity participants and/or related parties (as specified in Annex X E) are taken into consideration when determining the acceptable deviation for the current monitoring period if they have occurred and been recognised:

- in the audited financial statements for one of reporting periods T, T-1 or T-2; and/or
- in the accounting records up until the deadline for submission of the break-even information for reporting period T.

If contributions occurring until the deadline for submission of the break-even information for reporting period T are recognised in a licensee's reporting period T+1 and have been taken into consideration to determine the

acceptable deviation in respect of the current monitoring period, then for later monitoring periods the contributions will be considered as having been recognised in reporting period T.

For licensees assessed on the projected monitoring period, contributions from equity participants and/or related parties (as specified in Annex X E) are taken into consideration when determining the acceptable deviation if they have occurred and been recognised:

- a) in the audited financial statements for one of the reporting periods T or T-1; and/or
- b) in the accounting records for the reporting period T+1 up until the end of the licence season.

Illustrative example

Entity A has a statutory reporting date of 30 June. For the assessment of the break-even requirement in licence season 2018/19 for the current monitoring period:

Reporting period	T-4	T-3	T-2	T-1	T	T+1
Reporting period ending	30 June 2014	30 June 2015	30 June 2016	30 June 2017	30 June 2018	30 June 2019
Contributions (€m)	5	5	5	5	5	5*
Contributions taken into consideration for the current monitoring period assessment in 2018/19 (€m)	n/a	n/a	5	5	5 + 5*	n/a

* The contribution of €5m in the reporting period ending 30 June 2019 (T+1) occurred and was recognised prior to the deadline for submission of the break-even information for reporting period T and the licensee elects to have the contribution taken into consideration for the current monitoring period assessed in licence season 2018/19, i.e. treated as if the contribution had occurred in the financial statements for the reporting period ending 30 June 2018(T). Therefore, total contributions to be taken into consideration for the monitoring period assessed in 2018/19 are €20m.

For the assessment of the break-even requirement in the following licence season, 2019/20 for the current monitoring period:

Reporting period	T-4	T-3	T-2	T-1	T	T+1
Reporting period ending	30 June 2015	30 June 2016	30 June 2017	30 June 2018	30 June 2019	30 June 2020
Contributions (€m)	5	5	5	5	5**	0
Contributions taken into consideration for the current monitoring period assessment in 2019/20 (€m)	n/a	n/a	5	10**	0	n/a

**For the assessment of the break-even requirement for the current monitoring period assessed in licence season 2019/20, the contributions of €5m that occurred and were recognised between 1 July 2018 and the deadline for submission of the break-even information for reporting period T and were taken into consideration to determine the acceptable deviation in respect of the current monitoring period assessed in licence season 2018/19 must be treated as if they were contributions in the reporting period ending 30 June 2018 (which is now reporting period T-1).

3. Information to be disclosed in the contributions schedule in the BE.09 package

The following information must be disclosed in the contributions schedule:

- **For contributions from equity participants (Annex X E 2a) – share capital increase:**
 - the name of the equity participant,
 - the date of the transaction,
 - the type of consideration (e.g. cash, debt waiver, other consideration),
 - other explanatory comments, and
 - the amount allocated to the respective reporting period;

- **For monies received from a related party as a donation (Annex X E 3a):**
 - the name of the related party,
 - the date of the transaction,
 - the type of consideration (e.g. cash, debt waiver, other consideration),
 - other explanatory comments, and
 - the amount allocated to the respective reporting period; and
- **For income transactions from a related party (Annex X E 3b):**
 - the profit and loss account line in which the income transaction is included,
 - the date of the transaction,
 - the name of the related party,
 - the nature of the transaction, and
 - the amount allocated to the respective reporting period, the amount being the difference between the amount recorded in the profit and loss account and the fair value of the transaction; these details should match the information disclosed in the separate schedule for related-party transactions – see **Appendix V (B)**.

The amount in each reporting period must be disclosed separately for reporting periods T-2, T-1, T (including any amount in period T+1 that is being treated as occurring in reporting period T, as detailed above), and T+1. Amounts are to be input into the schedule in the entity's presentation currency, as positive figures and rounded to the nearest thousand.

In the contributions schedule, the input information is included in a summary table. If applicable, the total amount of disclosed contributions for each reporting period is translated to euros at the average rate of the relevant reporting period. The total amount of disclosed contributions is then utilised for the assessment of the break-even requirement.

Contributions							
Reporting period	T+1	T	T-1	T-2	Total		
Contributions from equity participants							
Gift / donations from related party							
Income transactions from related party							
Total contributions - LC							
Total contributions - EUR							
Contributions from equity participants - Share capital increase by shareholders							
Name of equity participants	Date (DD/MM/YYYY)	Type of consideration	Other comments	Amount - T+1 (LC)	Amount - T (LC) (Including amounts from T+1 to be included in T)	Amount - T-1 (LC)	Amount - T-2 (LC)
Total							
Gifts / donations from a related party							
Name of related party	Date (DD/MM/YYYY)	Type of consideration	Other comments	Amount - T+1 (LC)	Amount - T (LC) (Including amounts from T+1 to be included in T)	Amount - T-1 (LC)	Amount - T-2 (LC)
Total							
Difference of income / expenses transactions with a related party compared to fair value							
Describe account line	Date (DD/MM/YYYY)	Name of related party	Nature of the transaction	Amount - T+1 (LC)	Amount - T (LC) (Including amounts from T+1 to be included in T)	Amount - T-1 (LC)	Amount - T-2 (LC)
Total							

C. The break-even calculation

1. Break-even calculation schedule

There are break-even calculation schedules for both the local/reporting currency and euros, which summarise:

- the amounts of relevant income, relevant expenses, the break-even adjustments and the break-even result for each of the relevant reporting periods;
- the aggregate break-even result for the current and/or the projected monitoring period; and
- if applicable, the aggregate break-even surplus being the sum of the break-even results for the two reporting periods prior to the monitoring period.

If the licensee's aggregate break-even result for the monitoring period is a deficit, then it will be compared with the acceptable deviation.

In the break-even calculation schedule, the result is illustrated:

- by calculating the aggregate break-even result for the monitoring period;
- by including any break-even surplus for the sum of the break-even results of the two reporting periods prior to the monitoring period;
- by identifying the amount of contributions from equity participants and/or related parties occurring in the relevant time period – the amount of contributions to be considered is capped at €25m;
- by showing the applicable level of acceptable deviation – i.e. €5m plus any contributions up to the maximum level of €25m; and
- by showing any aggregate break-even deficit in excess of the acceptable deviation.

If a licensee has a reporting period greater or less than 12 months, then the acceptable deviation is adjusted up or down according to the length of the monitoring period (see **Appendix VII**). For the avoidance of doubt, the break-even calculation schedule is provided in the CL/FFP IT Solution to assist licensees own assessment of their break-even information.

2. Potential outcomes of the break-even calculation assessment

In summary, there are four scenarios in respect of the outcome of the assessment of the break-even requirement. Below, these scenarios are illustrated by examples.

Illustrative examples:

By way of illustration, the maximum level of acceptable deviation is an amount of up to €30m, in so far as the excess over €5m is entirely covered by contributions. Figures are in millions of euros (€m).

Scenario 1 : Licensee with a break-even surplus for both reporting periods T-2 and T-1 and that does not submit break-even information for the reporting period T.

The break-even requirement at the end of T is not systematically assessed (risk based assessment) if the licensee has a break-even surplus for both reporting periods T-2 and T-1 and has not to submit break-even information for the reporting period T.

Example 1: licence season 2018/19

Reporting period (Reporting period ending in year)	T-2 (2016)	T-1 (2017)	T (2018)
Annual break-even result	+2	+1	n/a
Outcome: The submission of reporting period T is not requested			
No indicators breached and break-even surplus in both T-1 and T-2, so the licensee does not need to submit break-even information for T.			

Scenario 2 : Licensee assessed on the current monitoring period and reports an aggregated break-even surplus.

Article 64(1a): The break-even requirement is fulfilled, if the licensee is assessed on the current monitoring period and it has an aggregated break-even surplus for reporting periods T-2, T-1 and T.

Example 2: licence season 2018/19 – current monitoring period

Reporting period (Reporting period ending in year)	T-2 (2016)	T-1 (2017)	T (2018)
Annual break-even result	+2	-1	+3
Aggregate break-even result for the current monitoring period	+4		
Outcome: requirement fulfilled			
There is a break-even deficit for T-1 (€1m), so the licensee must submit break-even information for T. The aggregate break-even result for the monitoring period is a surplus, so the break-even requirement is fulfilled.			

Scenario 3: Licensee assessed on the current monitoring period and reports an aggregated break-even deficit within the acceptable deviation having also taken into account the surplus of T-3 and T-4.

Article 64(1b): The break-even requirement is fulfilled, if the licensee is assessed on the current monitoring period and, it has an aggregate break-even deficit for reporting periods T-2, T-1 and T which is within the acceptable deviation (as defined in Article 61), having also taken into account the surplus (if any) in the reporting periods T-3 and T-4 (as defined in Article 60(6)).

Example 3: licence season 2018/19 – current monitoring period

Reporting period (Reporting period ending in year)	T-2 (2016)	T-1 (2017)	T (2018)
Annual break-even result	-3	-2	-2
Aggregate break-even result for the current monitoring period	-7		
Sum of break-even results for T-3 (2015) and T-4 (2014)	+3		
Aggregate break-even result (having taken into account the sum of the surplus of T-3 and T-4)	-4		
Contributions from equity participants and/or related parties	0		
Acceptable deviation	-5		
Outcome: requirement fulfilled			
The aggregate break-even result (having taken into account the sum of the surplus of T-3 and T-4) is a deficit of €4m, which is within the acceptable deviation of €5m (deficit), so the break-even requirement is fulfilled. .			

Scenario 4: Licensee assessed on the current and the projected monitoring periods.

Article 64(1b): The break-even requirement is fulfilled if the licensee has aggregated break-even deficit for each of the current monitoring period (T-2, T-1 and T) and for the projected monitoring period ending (T-1, T, T+1) which is within the acceptable deviation (as defined in Article 61), having also taken into account the surplus from the two reporting periods prior to the monitoring period. (as defined in Article 60(6)).

Example 4: licence season 2018/19

Current monitoring period

Reporting period (Reporting period ending in year)	T-2 (2016)	T-1 (2017)	T (2018)
Annual break-even result	-3	-2	-2
Aggregate break-even result for the current monitoring period	-7		
Sum of break-even results for T-3 (2015) and T-4 (2014)	+3		
Aggregate break-even result (having taken into account the sum of the surplus of T-3 and T-4)	-4		
Contributions from equity participants and/or related parties	0		
Acceptable deviation	-5		
Outcome: the break-even deficit is within the acceptable deviation for the current monitoring period			

The aggregate break-even result (having taken into account the sum of the surplus of T-3 and T-4) is a deficit of €4m, which is within the acceptable deviation of €5m (deficit).

Projected monitoring period:

Reporting period (Reporting period ending in year)	T-1 (2017)	T (2018)	T+1 (2019)
Annual break-even result	-2	-2	-4
Aggregate break-even result for the projected monitoring period	-8		
Sum of break-even results for T-2 (2016) and T-3 (2015)	+5		
Aggregate break-even result (having taken into account the sum of the surplus of T-2 and T-3)	-3		
Contributions from equity participants and/or related parties	0		
Acceptable deviation	-5		
Outcome: the break-even deficit is within the acceptable deviation for the projected monitoring period The aggregate break-even result (having taken into account the sum of the surplus of T-2 and T-3) is a deficit of €3m, which is within the acceptable deviation of €5m (deficit)			

The break-even results for the current and the projected monitoring period are within the acceptable deviation of €5m so the break-even requirement is fulfilled.

Scenario 5: Licensee assessed on the current monitoring period and reports an aggregated break-even deficit.

Article 64 (2): The break-even requirement is not fulfilled if the licensee has an aggregate break-even deficit for the current monitoring period T-2, T-1 and T exceeding the acceptable deviation (as defined in Article 61), having also taken into account the surplus (if any) in reporting periods T-3 and T-4 (as defined in Article 60 (6)).

In other words, for the monitoring period assessed in 2018/19, the aggregate break-even deficit is either:

- between €5m and €30m, where the excess deficit over €5m is not entirely covered by contributions; or
- in excess of €30m, regardless of any contributions.

Example 5: licence season 2018/2019 – current monitoring period

Reporting period (Reporting period ending in year)	T-2 (2016)	T-1 (2017)	T (2018)
Annual break-even result	0	-10	-5
Aggregate break-even result for the current monitoring period	-15		
Contributions from equity participants and/or related parties	5		
Acceptable deviation	-10		
Outcome: requirement breached The aggregate break-even deficit (€15m) is not within the acceptable deviation (€10m deficit; being €5m + €5m contributions), so the break-even requirement is not fulfilled.			

Example 6: licence season 2018/2019 – current monitoring period

Reporting period (Reporting period ending in year)	T-2 (2016)	T-1 (2017)	T (2018)
Annual break-even result	0	-30	-30
Aggregate break-even result for the current monitoring period	-60		
Contributions from equity participants and/or related parties	25 (maximum level)		
Acceptable deviation	-30		
Outcome: requirement breached			
The aggregate break-even deficit (€60m) is not within the acceptable deviation (€30m deficit; €5m + €25m contributions), so the break-even requirement is not fulfilled.			

Scenario 6: Licensee assessed on the current and the projected monitoring periods and reports an aggregated break-even deficit at least in one of the monitoring periods.

Article 64 (2): The break-even requirement is not fulfilled if the licensee has an aggregate break-even deficit for the current monitoring period or for the projected monitoring period exceeding the acceptable deviation (as defined in Article 61), having also taken into account the surplus (if any) in two reporting periods prior to the monitoring period assessed.

In other words, for the monitoring periods assessed in 2018/19, at least one of the aggregate break-even deficit is either:

- between €5m and €30m, where the excess deficit over €5m is not entirely covered by contributions; and/or
- in excess of €30m, regardless of any contributions.

Example 7: licence season 2018/19

Current monitoring period:

Reporting period (Reporting period ending in year)	T-2 (2016)	T-1 (2017)	T (2018)
Annual break-even result	40	-20	-30
Aggregate break-even result for the current monitoring period	-10		
Contributions from equity participants and/or related parties	25 (maximum level)		
Acceptable deviation	-30		
Outcome: requirement fulfilled for the current monitoring period			
The aggregate break-even deficit (€10m) is within the acceptable deviation (€30m deficit; €5m + €25m contributions), so the break-even requirement of the current monitoring period is fulfilled.			

Projected monitoring period:

Reporting period (Reporting period ending in year)	T-1 (2017)	T (2018)	T+1 (2019)
Annual break-even result	-20	-30	0
Aggregate break-even result for the projected monitoring period	-50		
Contributions from equity participants and/or related parties	25 (maximum level)		
Acceptable deviation	-30		
Outcome: requirement breached for the projected monitoring period			
The aggregate break-even deficit (€50m) is not within the acceptable deviation (€30m deficit; €5m + €25m contributions), so the break-even requirement of the projected monitoring period is not fulfilled.			

Despite a break-even deficit for the current monitoring period within the acceptable deviation, the break-even requirement is not fulfilled because the licensee has one of its monitoring period under assessment (i.e. the projected monitoring period) with a deficit exceeding the acceptable deviation.

APPENDIX VII: GUIDANCE FOR BE PACKAGE – REPORTING PERIODS OTHER THAN 12 MONTHS

A. Information to be submitted by the licensee

For the purpose of the break-even requirement, a licensee must prepare and submit financial information based on and reconciled to audited financial statements for a reporting period ending in each relevant calendar year, regardless of their actual statutory closing date.

Typically, a licensee's reporting period will cover a twelve month period and its statutory closing date will be the same from one year to the next.

As detailed in **Section 4.1.3**, the licensee must ensure that the pre-populated reporting period closing month shown in the CI package is correct. If it is incorrect the licensee must contact UEFA administration before entering any data.

If a licensee changes its statutory closing date and consequently it does not have a statutory closing date in a particular calendar year, then the licensee must still prepare audited financial statements for a reporting period ending in that calendar year.

Illustrative example

- A licensee changes its statutory closing date from 31 December 2016 to 30 June 2018, so the licensee has statutory financial statements covering the 12 months to 31 December 2016 and then 18 months to 30 June 2018.
- Therefore, the licensee has no statutory closing date ending in the calendar year of 2017.
- Under Article 48 the licensee must prepare and submit additional financial statements covering an interim period ending on a date within six months preceding the deadline for submission of the list of licensing decisions to UEFA (e.g. an interim period to 31 December 2017).

Therefore, for the 2018/19 licence season the break-even information will comprise:

- for T-2, the 12 months to 31 December 2016 (based on audited annual financial statements);
- for T-1, the 12 months to 31 December 2017 (based on audited interim financial statements to 31 December 2017); and
- for T, the 6 months to 30 June 2018 (based on the audited financial statements for the 18 months to 30 June 2018, as adjusted for the interim financial statements to 31 December 2017).

B. Flexing threshold levels for exemption (Article 57(4))

As detailed in Section 5.1.5, a licensee can only be exempt if it can demonstrate it has relevant income and relevant expenses below €5m in respect of each of the two reporting periods ending in the two years prior to commencement of the UEFA club competition in question.

As per Article 57, if the reporting period is greater or less than 12 months, the €5m threshold (relevant income/expenses) for exemption is adjusted up or down according to the length of the reporting period. The flexed threshold level is then compared to the licensee's relevant income and expenses as appropriate.

Having submitted the break-even information, including information about the length of the reporting periods (as contained in the CI package), the licensee will be notified if further break-even information is required.

C. Flexing acceptable deviation (Article 61(5))

In accordance with Article 61(5), for monitoring periods containing a reporting period of greater or less than 12 months, the acceptable deviation will be adjusted up or down according to the length of the monitoring period.

Illustrative example for reporting period of less than 12 months

- This is illustrated below for a licensee which, following a change in its statutory closing date, has a six-month reporting period in 2018 and therefore a monitoring period of 30 months, instead of 36 months, for the break-even assessment for licence season 2018/19.

- The level of acceptable deviation, without and with contributions, is adjusted downwards for a monitoring period containing a reporting period of less than 12 months:

As assessed in licence season:	Reporting periods (number of months)						Months in the monitoring period	If no contributions, aggregate break-even deficit up to	If excess over €5m is covered by contributions, aggregate break-even
	31-Dec-16	31-Dec-17	31-Dec-18	31-Dec-19	31-Dec-20	31-Dec-21			
2018/2019	12	12	6				30	4.2	25
2019/2020		12	6	12			30	4.2	25
2020/2021			6	12	12		30	4.2	25
2020/2022				12	12	12	36	5.0	30

Illustrative example for reporting period of greater than 12 months

- The illustration below is for a licensee which, following a change in its statutory closing date, has a 15-month reporting period in 2018 and therefore a monitoring period of 39 months, instead of 36 months, for the break-even assessment for licence season 2018/19.
- The level of acceptable deviation, without and with contributions, is flexed up for a monitoring period containing a reporting period of greater than 12 months:

As assessed in licence season:	Reporting periods (number of months)						Months in the monitoring period	If no contributions, aggregate break-even deficit up to	If excess over €5m is covered by contributions, aggregate break-even deficit up to:
	31-Dec-16	31-Dec-17	31-Dec-18	31-Dec-19	31-Dec-20	31-Dec-21			
2018/2019	12	12	15				39	5.4	32.5
2019/2020		12	15	12			39	5.4	32.5
2020/2021			15	12	12		39	5.4	32.5
2020/2022				12	12	12	36	5.0	30

APPENDIX VIII: GUIDANCE FOR BE PACKAGE – EXCHANGE RATES (OTHER THAN €)

A. Applicable exchange rates (Article 57)

If a licensee's **financial information is denominated in a currency other than euros**, the relevant figures are converted into euros at the **average exchange rate of the reporting period** (or at the assessment date in the OP package), using exchange rates published by the European Central Bank or other appropriate source.

As detailed in **Section 4.1.3**, the licensee must check that the pre-populated information for the licensee's local/reporting currency in the CI package is correct. If the pre-populated currency is incorrect then the licensee must contact UEFA administration immediately, before inputting any data.

For historical periods covering T-2, T-1 and T the local/reporting currency is converted to euros using the average exchange rate for the period. For reporting periods which have yet to close (i.e. T+1 and, in some cases, T) the latest available exchange rates are used and extrapolated over 12 months.

B. Impact of conversion of accounts in local reporting currency into euros (Annex XI C)

The "Other factor" in Annex XI refers solely to the impact on the licensee's break-even result in euros as a result of the conversion of the financial results from the local/reporting currency into euros.

The break-even result for a reporting period as calculated in the local/reporting currency of the reporting entity will be translated into euros at the average rate of the reporting period, in accordance with the Article 57(3). If exchange rates change over time such that there is an adverse impact on the licensee's break-even result denominated in euros for a reporting period or in aggregate for a monitoring period, compared with the currency used for its annual financial statements, then the amount of the impact of conversion of accounts will be taken into consideration.

If the break-even result for the monitoring period in the local/reporting currency is positive, the licensee should, in principle, not be sanctioned.

Each reporting entity has a selected reporting currency for its annual financial statements. An entity may have transactions in currencies other than its reporting currency and/or it may have foreign operations. Each entity must account for any currency exchange differences in its annual financial statements in accordance with applicable accounting standards. Such exchange differences do not constitute the "other factor" listed under the impact of conversion of accounts in local currency into euros in Annex XI. The management of currency risks remains the entity's responsibility and cannot be excluded from the break-even calculation.

Illustrative examples

- In the illustrative examples below, the licensee complies with the break-even result using the currency applied in its financial statements in both scenario 1 and scenario 2. However, due to the adverse movement of its currency against the euro during period T in scenario 2, it breaches the break-even result denominated in euros. If the exchange rate had remained at 1.5 in reporting period T, as shown in scenario 1, the club would have complied with the break-even requirement denominated in euros.
- This adverse impact of the exchange rate against the euro will be taken into consideration.

Scenario 1

Reporting period	T-2	T-1	T	Aggregate for monitoring period
Break-even result local currency	-16,000	5,000	11,000	0
Exchange rate	1.5	1.5	1.5	n/a
Break-even result (€000)	-24,000	7,500	16,500	0

Scenario 2:

Reporting period	T-2	T-1	T	Aggregate for monitoring period
Break-even result local currency	-16,000	5,000	11,000	0
Exchange rate	1.5	1.5	1.0	n/a
Break-even result (€000)	-24,000	7,500	11,000	-5,500

APPENDIX IX: GUIDANCE FOR DUTY TO REPORT SUBSEQUENT EVENTS

In accordance with Article 67, the licensee must promptly notify the licensor in writing about any significant changes including, but not limited to, subsequent events of major economic importance until at least the end of the licence season.

Examples of events or conditions which, individually or collectively, may be considered a significant change include, but are not limited to, the following:

- any alteration to the licensee's legal form or company structure (including, for example, changing its headquarters, name or club colours, or transferring shareholdings between different clubs);
- any alteration to reporting perimeter;
- a material change to accounting policies, compared to the audited annual financial statements as submitted for club licensing;
- if a licensee is in breach of any conditions in respect of the issue of the licence;
- if a licensee violates any of its obligations under the national club licensing regulations;
- fixed term borrowing approaching maturity without realistic prospects or renewal or repayment;
- indications of withdrawal of financial support by any of the club's material lenders, including a breach of covenant(s);
- discovery of material fraud or errors that show the financial statements are incorrect;
- determination of pending legal proceedings against the club that result in claims that are unlikely to be satisfied;
- the executive responsibilities of the licensee are being undertaken by a person(s) under some form of external appointment, relating to legal or insolvency procedures; and
- if the licensee (or the registered member of the UEFA member association which has a contractual relationship with the licensee within the meaning of Article 12) or any other entity in the reporting perimeter seeks or receives protection from its creditors and/or is subject to insolvency proceedings pursuant to laws or regulations.

APPENDIX X: GUIDANCE FOR APPLYING TO ENTER A VOLUNTARY AGREEMENT

As set out in **Article 57(5)** and **Annex XII**, under certain circumstances a licensee may apply to enter into a voluntary agreement with the CFCB with the aim of future compliance with the break-even requirement.

1. Eligibility for applying to enter into a voluntary agreement

By way of illustration, a club is eligible to apply to enter into a voluntary agreement effective from the 2019/20 UEFA club competition if:

- it has been granted a valid licence to enter the 2018/19 UEFA club competitions by its national licensor but has not qualified for a 2018/19 UEFA club competition; or
- it has qualified for and entered a 2018/19 UEFA club competition and proves that the aggregate break-even result for the reporting periods ending in 2016, 2017 and 2018 is within acceptable deviation; or
- it has been subject to a significant change in ownership and/or control during the period 1 January 2018 to 31 December 2018 (e.g. the ultimate controlling party has changed and the new ultimate controlling party is not a related party of the previous ultimate controlling party).

Notwithstanding a club satisfying any of the three conditions described above, a club is only eligible to apply to enter into a voluntary agreement with the CFCB if it has not been party to a voluntary agreement or subject to a disciplinary measure or settlement agreement (as foreseen in the Procedural Rules Governing the UEFA Club Financial Control Body) within the last three reporting periods.

2. Deadlines for the process for applying to enter into a voluntary agreement

Deadlines for a club to apply to enter into a voluntary agreement effective from the reporting period ending 2019:

Date	Description
30 November 2018	For a licensee considering applying for a voluntary agreement, deadline for notifying the UEFA administration (by email to ffpsupport@uefa.ch) and asking the UEFA administration to open the relevant CL/FFP IT Solution package(s). The licensee's notification request must include contact details comprising its full legal name, postal address, email address and telephone number.
14 December 2018	Deadline for the licensee to submit to the UEFA administration: <ul style="list-style-type: none"> • If not previously submitted by the licensee, the BE.2018.09 package including the break-even information for the financial reporting periods ending 2016 (T-2), 2017(T-1) and 2018 (T) as well as the projected break-even information for the reporting period ending 2019 (T+1); and • BP.2018.01 package including the projected break-even information for the financial reporting periods ending 2020 (T+2), 2021(T+3) and 2022(T+4) – the licensee may attach additional supporting documentation to the package. Note: The BP.2018.01 package will also include the break-even information for reporting periods ending in 2018(T) and 2019 (T+1), pre-populated from the submission of the BE.2018.09 package.
31 December 2018	Deadline for the licensee to submit to the CFCB the licensee's application request for entering into a voluntary agreement in the form to be communicated by the UEFA administration) which, if such agreement is concluded in due course, would come into force for the reporting period ending 2019(T+1) and cover up to and including the reporting period ending 2022 (T+4).

3. Information requirements for applying to enter into a voluntary agreement

As part of a club's application for entering into a voluntary agreement commencing from reporting period 2019, it must prepare and submit a long-term business plan including projected break-even information covering the reporting periods ending 2019(T+1), 2020(T+2), 2021(T+3) and 2022 (T+4).

The projected break-even information must:

- be prepared and submitted in the prescribed format as contained in the schedules in the BE.09 package (for T+1) and in the BP.01 package (for T+2, T+3 and T+4), including a balance sheet, a profit and loss account and a cash flow statement;
- be prepared on a basis consistent with that required for T+1, as set out in the Regulations and further explained in this FFP Toolkit (see sections 5.1.2 and 5.1.10);
- demonstrate its ability to continue as a going concern until at least the end of the period covered by the voluntary agreement, including entering the amounts of future commitment(s) by equity participants and/or related parties to make contributions to at least cover the aggregate projected break-even deficits for all the future reporting periods intended to be covered by the voluntary agreement; and
- demonstrate compliance with the break-even requirement. For a club applying to enter into a voluntary agreement covering the reporting periods ending 2019(T+1), 2020(T+2), 2021(T+3) and 2022 (T+4), the club should demonstrate compliance with the break-even requirement for the monitoring period which would be assessed in licence season 2022/23 covering the reporting periods ending 2020, 2021 and 2022.

4. Possibility for entering a voluntary agreement

The CFCB will review each application and the information provided and contact will be made with the respective club about any additional information requirements and the possible conclusion of a voluntary agreement.

As set out in Annex XII, as part of any such agreement between the CFCB and a club, a club must:

- Submit irrevocable commitments by equity participants and/or related parties to make contributions for an amount at least equal to the aggregate future break-even deficits for all the reporting periods covered by the voluntary agreement. This irrevocable commitment must be evidenced by way of a legally binding agreement between the licensee and the equity participants and/or related parties and, if required by the CFCB, it must also be secured by means of either:
 - payments into an escrow account, or
 - any other such form of security as the CFCB considers satisfactory. For example, a guarantee from another company in the legal group structure outside the reporting perimeter
- Demonstrate to the satisfaction of the CFCB its ability to meet the targets and obligations agreed in the voluntary agreement.

INDEX

Acceptable deviation	23, 113
Adjustments	16, 80, 99
Agreed transfer compensation	29
Amortisation/impairment of intangible fixed assets (excluding player registrations)	71
Amortisation/impairment of player registrations	73
Balance sheet	15, 52
Break-Even package (BE package)	13, 40, 52, 80, 104
Break-Even requirement	14, 24, 104, 107
Break-Even result	16, 23, 80
Broadcasting rights revenue	65
Capital contributions being a contribution by a related party	105
Cash flow statement	15, 78
CL/FFP IT Solution	3
Club Financial Control Body	2
Club Information package (CI package)	9, 47
Club Monitoring Process	5
Commercial activities revenue	66
Community development expenditures	93, 94
Conditional transfer compensation	30
Construction of tangible fixed assets	99
Contributions	23, 105
Contributions from equity participants and/or related parties	105
Controlling party	44
Cost of sales/materials	69
Currency	10, 115
Current assets and non-current assets	53
Current liabilities and non-current liabilities	54
Disposal of tangible fixed assets	75, 95
Employee benefit expenses	69
Employee payables	33
Equity	55
Exemption from the break-even requirement	17
Fair Value	85, 96
Finance income	76
Financial Statements package (FS package)	7, 40, 52
Gate receipts revenue	63
Income transactions from a related party	105
Indicators	18
Key dates and deadlines	38
Legal group structure	44
Management representation	11, 24, 36
Method of accounting for player registration	101
Method of accounting for player registrations	72
Non-football operations	90, 92
Non-monetary items	89, 100
Other income and expenses	76
Other operating expenses	71
Other operating income	68
Overdue Payables package (OP package)	27
Player trading	72
Profit and loss account	15, 60
Profit/loss on disposal of intangible fixed assets (excluding player registrations)	75
Profit/loss on disposal of player registrations	73
Reconciliation	56, 58, 60
Related parties	17, 53, 54, 81, 105
Relevant expenses	80
Relevant income	80
Reporting perimeter	8, 10, 47
Reporting period	10
Reporting periods other than 12 months	113
Responsibilities of licensees	9, 13, 27

Responsibilities of licensors	12, 25, 37
Social/tax payables	27, 35, 55
Solidarity/training compensation	31
Sponsorship and advertising revenue.....	64
Subsequent events	4, 116
Supplementary schedules	93
Tax income/expense	77
Transfer payables	27, 32, 35, 36
Transfer payables schedule	27
Transfer payables summary.....	31
UEFA solidarity & prize money	67
Youth development expenditures	93